

Pipeline Current Mapper User Guide

Revision 7 04.11.02

Pipeline Current Mapper User Guide

Trouble Shooting

When reporting any problem to your Radiodetection Dealer/Supplier it is important to quote the following:

Equipment Serial Number.
Software Revision Number.

Software Revision Number is displayed on the LCD during switch on.

Warning

Radiodetection Receivers detect almost all buried cables and most conductors, but there are some which do not radiate signals and which Radiodetection receivers cannot detect. Radiodetection receivers do not indicate whether a signal is from a single cable, several buried side by side or one above another.

This equipment is NOT approved for use in areas where hazardous gases may be present.

Reduce audio level before using headphones.

Ni-Cad batteries should be disposed of in accordance with your Company's work practice, and/or the relevant law or guidelines in your country.

Warning

The operation of any cable and pipe locator may be affected when used in close proximity to ferrous materials such as manhole covers and parked cars. Keep a one or two meter distance from these objects when taking critical measurements such as depth and current readings. Standing too close to the locator when wearing steel toe capped boots may also affect the readings.



This instrument, or family of instruments, will not be permanently damaged by reasonable electrostatic discharge and has been tested in accordance with IEC 801-2. However, in extreme cases temporary malfunction may occur. If this happens, switch off, wait and switch on again. If the instrument still malfunctions, disconnect the batteries for a few seconds.

Pipeline Current Mapper User Guide

CONTENTS

<u>Title</u>	<u>Section</u>	<u>Page</u>
Introduction.....		1
Step by Step Guide to Current Mapping		
PCM System.....		3
PCM Transmitter Functions.....	1.....	4
Signal Connection		6
PCM Receiver Functions.....	2.....	11
Steps in Pipeline Current Measurement.....		15
PCM Receiver Use – Basic Locating, Technique, Depthing	3.....	18
Mapping Current Theory using dBmA.....	4.....	22
Taking Measurements	5.....	24
Applications case studies	6.....	27
Using Accessory A Frame with PCM	7.....	30
Identifying Interference	8.....	33
Avoiding errors and Interpreting Results	8.....	34
Error Codes	9.....	36
Changing LCD Display	10.....	37
PCM Software Instructions, versions V 1.1 and V 2.1	11.....	39
Preparing PCM Graphs using Microsoft Excel Spreadsheets.....	12.....	44
Distance/Current.....		45
Distance/Current & Depth		49
Distance/Current & Current Loss Rate.....		57
Using PCM system with Datalogger and GPS.....	13.....	63
PCM Features and Specifications	14.....	69
Configuration and operation of Trimble GPS Pathfinder.....	Appendix 1.....	80

Pipeline Current Mapper User Guide

Pipeline Current Mapper User Guide

Introduction

The Pipeline Current Mapper (PCM) system from Radiodetection enables the pipeline industry to overcome the limitations of existing techniques used in evaluating the effectiveness of cathodically protected pipes. This new technology enables shorts caused by contact with other metallic structures and coating defects to be identified. The system is the subject of patent applications.

Traditional Cathodic Protection (CP) surveys measure the voltage potential of the pipe with respect to the earth around it to show that the pipe is protected against corrosion. Some pipes, due to coating degradation or damage have low protection voltages and are at risk of increased corrosion damage. Simple Ohms law shows that adding more current will cause more voltage, but higher rectifier output voltages have been shown to speed the degradation of coatings. Another side effect is that more current flowing can cause embrittlement of the pipeline metal leading to premature (and possibly catastrophic) failures.

The PCM provides a new method to quickly locate faults and poor coating that is draining the current, resulting in improved potentials and minimising damaging side effects. A PCM does not replace a Close Interval Potential Survey (CIPS) as current flow and voltage potentials are related but other factors vary this relation. The use of a Potential Survey is still required to verify protection levels, usually after the rehabilitation work designed around PCM results is completed.

The PCM System:

- Consists of a portable transmitter and a hand held receiver. The transmitter applies a special near DC signal to the pipeline.
- The receiver locates this unique signal on the pipeline and displays the signal's current magnitude and direction without connection to the pipeline.
- Accurately and easily locates and maps the pipeline even in areas where there is contact with other metallic structures, interference, or congestion.
- Provides a current profile and current direction that is virtually the same as the CP currents on the pipeline. (* see footnote)
- Provides an accurate evaluation of the condition of the coating of a section of pipe.
- Reduces false indications and thereby minimises unnecessary excavations.
- Provides data logging and on-site review of readings (receiver stores 100 or 399 readings) and permits a graph to be printed from stored readings via a PC or Laptop.
- Can be supplied with Accessory A frame, and used to pinpoint coating defects.
- Reduces operational and maintenance costs and speeds up survey time.
- Eliminates the need for the operator to perform 'current spans' and manual calculations to determine CP currents along the pipeline that require connection to the pipeline.
- Is designed for the Pipeline Industry with guidance and support from Gas Industry leaders.
- The PCM is one part of the Radiodetection Pipeline Product range, which also includes the Stray Current Mapper, Precision Pipe Locator, Pipeline Vector Bar and Smart Interrupter.

*Investigation of PCM Current relative to DC pipeline current, 29 November 1997, by Martin J. Frazier, Corr Comp Co, Schaumburg, IL 60193. Copies of this paper can be purchased from Radiodetection.

Pipeline Current Mapper User Guide

Step by Step Guide to Mapping

	Section	Pages
PCM Transmitter Set Up		
• Connect output leads	1	6&7
- WHITE to pipeline.	1	6&7
- GREEN to anode, EIJ or suitable grounding point	1	6&7
	1	6&7
• Select Mapping frequency.	1	4
• Connect Power source.	1	10
• Switch on transmitter.	1	4&5
• Set current output level.	1	4&5
 PCM Receiver Set Up		
• Slide on and connect PCM Magnetometer foot		
• Check Battery level, replace if necessary.	2	11
• Set to same mapping frequency as transmitter.	2	12
• Set to Peak mode.	2	12
 Good local knowledge, a map and a notepad are essential to obtaining the correct information		
• Use the map, locate the pipeline and move at least 30 - 50 M from the transmitter.		
• 1. Use the receiver and verify that the PEAK and NULL positions are within 15 cm/6 inches.	3	18&19
• 2. Obtain depth reading. A sensible reading indicates a site free from interference.	3	20
• 3. Press mapping key to obtain PCM current reading.	2	15
• 4. Press the ✓ key to save result and note log number on notepad and map.	2	15
• 5. Use map to select next mapping location, or continue along the pipeline for predetermined distance. 50 – 100 Metres is adequate.		
• 6. Select Null mode and trace pipeline to next mapping location.	3	18&19
• Repeat procedures 1 – 6 until pipeline survey is complete.		
• Use Accessory A Frame to pinpoint fault	7	30-32
• Upload results to PC, and prepare graph of current against distance (see Upload and Software section)	2	17
	11	39-43
	12	44-63
• Archive results for future reference	12	44-63

Pipeline Current Mapper User Guide

PCM System

PCM Transmitter

The PCM system's specialised constant current high-power transmitter allows for long range signal detection of up to 30 km (20 miles). Significantly fewer pipeline connection points are needed thereby reducing the time required to evaluate a section of pipeline.

The transmitter has three operating modes that enable both distribution and transmission pipeline systems to be effectively mapped.

Connecting the PCM is straightforward, and the transmitter's current reading LCD and power indicating LED's help the operator to choose the best settings for the specific pipeline application.

Use of PCM Transmitter see section 1.

PCM Receiver

The hand held receiver unit is used to locate the pipeline, even in heavily congested areas, and then provides the operator with a measurement of depth current strength and direction of the near DC signal applied by the system's transmitter.

The receiver makes the required calculations and instantaneously displays the results. This provides the operator with an improved method that accurately troubleshoots the CP system by pinpointing metallic contacts and locating areas of coating defects.

Use of PCM receiver see section 2.

PCM Attachment (magfoot)

This contains the magnetometer (*mag foot*) that detects the near DC mapping current. The PCM magnetometer foot is switched on when the PCM current key is pressed to take a PCM measurement.

When the PCM foot is fitted to the PCM receiver there will be a confirming "beep" from the loudspeaker.

The PCM magfoot also stores the pipeline current mapping results in the built in datalogger, and it must be attached to the receiver to upload results to PC.

Use of PCM magfoot attachment see section 2.

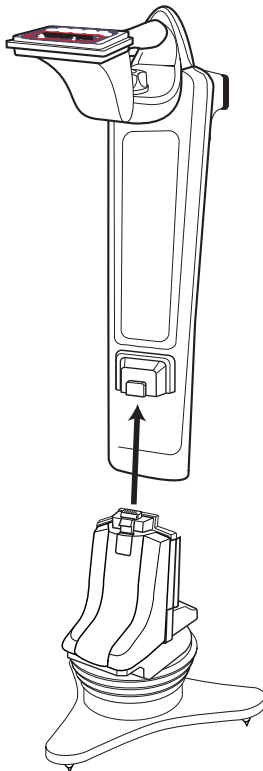
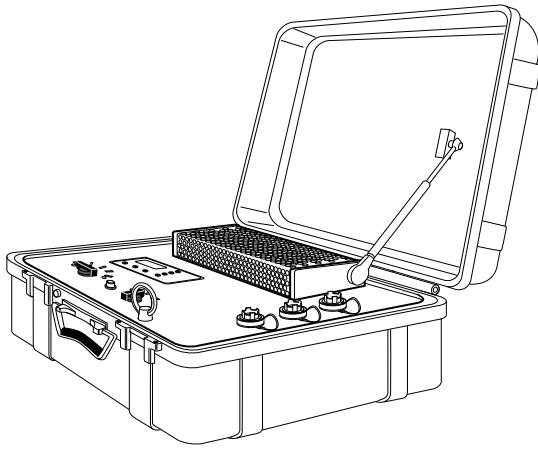

Pipeline Current Mapper User Guide

Section 1

PCM Transmitter Functions

The PCM transmitter is housed in a rugged waterproof case which can be opened easily by applying a slight pressure to the top of the case just above the clips. The clips will then open freely.

In certain situations the air pressure within the case may need to be equalised by unscrewing the small knob located by the handle.

The case needs to remain open during operation to allow the heat sink to cool.

When closing case ensure connection cables are kept away from the heat sink and the support strut.

Frequency Select

The 4 Hz output current is shown on the LCD.

The three-position rotary switch selects the applied mapping frequencies as follows:

TRANSMISSION LINES

ELF maximum range.

- 35% 4 Hz
- 65% ELF (128 Hz or 98 Hz)

TRANSMISSION AND DISTRIBUTION LINES

ELF current direction, medium range.

- 35% 4 Hz
- 30% 8 Hz (current direction)
- 35% ELF (128 Hz or 98 Hz)

DISTRIBUTION LINES

LF current direction, alternative frequency.

- 35% 4 Hz
- 30% 8 Hz (current direction)
- 35% LF (640 Hz or 512 Hz)

The 4 Hz mapping frequency is always present.

The operator has a choice of selecting the locate frequency and current direction indication if required for identification in congested areas or for fault finding.

Current Select

The six position Current Select rotary switch selects the following rms 4 Hz current settings: 100 mA, 300 mA, 600 mA, 1 A, 2 A, 3 A.

When the PCM Transmitter is in operation, the selected current will remain at a constant level, unless input power supply limit is reached.

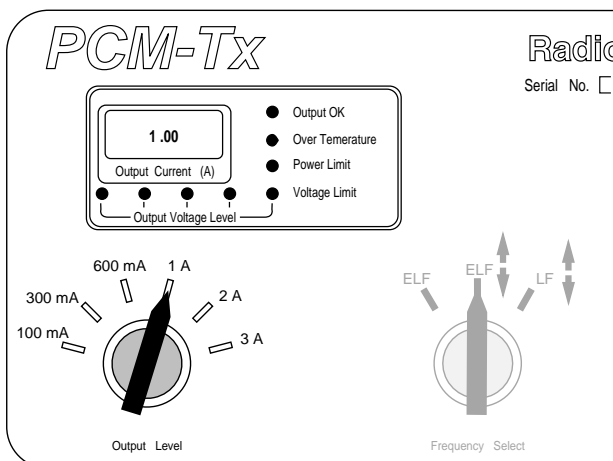
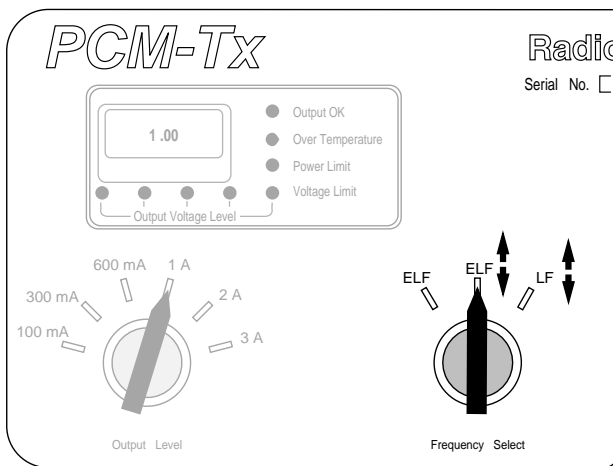

Pipeline Current Mapper User Guide

Section 1

Warning Lights and output indication

Output voltage indicated by yellow output voltage level LED 's.

If no lights are lit the voltage is below 20V.

If the 20V LED is lit, the voltage applied is between 20 – 40V.

If the 40V LED is lit, the voltage applied is between 40 – 60V.

If the 60V is lit the voltage applied is between 60 – 80V.

If the 80V LED is lit the voltage is between 80 – 100V.

Voltage Limit

Transmitter is at the 100V output voltage limit.

The resistance of the pipe or ground connection is too high. Check all connections.

Warning

If the pipeline being surveyed has coating that is known to be in good condition, it is probable that the voltage warning LED's will illuminate as the current is increased.

If the 60V/80V/100V lights are illuminated, do not use excessive voltage or current, as this may result in high current density through small holidays and coating defects. This may cause minor corrosion if the transmitter is left switched on for very long periods.

LCD display

The 3 digit LCD displays the 4 Hz signal current in amps that is being delivered onto the pipe.

Transmitter status indicated by the following LEDs:

GREEN	Output OK
RED	Over Temperature
RED	Power Limit
RED	Voltage Limit

Over Temperature

The transmitter will automatically shut down, and can be switched on again when it has cooled.

Power Limit

External power supply not capable of supplying the demanded power to support transmission at the selected current. The transmitter has reached its own power limit.

Switch to a lower current setting until the GREEN Output OK LED comes on. Allow a few seconds to settle between selections.

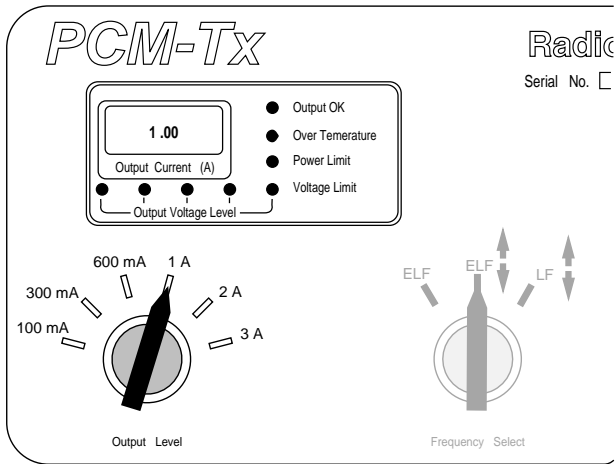

Pipeline Current Mapper User Guide

Section 1

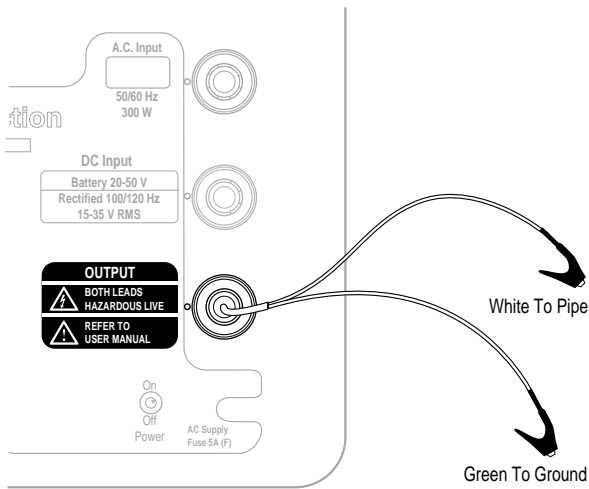

SIGNAL CONNECTION



Warning

Appropriate safety procedures must be followed before removing pipeline CP connection.



Warning

Before handling connection leads switch transmitter OFF.

- Disconnect both pipe and anode cables from the rectifier
- Ensure the transmitter is turned off.
- Connect the White signal output lead to the pipe cable.
- Connect the Green signal output lead to a suitable anode cable.

Note: If connections are reversed the current direction arrow on the PCM Receiver will point in the wrong direction.

Use an isolated low resistance ground such as a sacrificial magnesium anode or ground bed.

When connecting to an electrical isolation joint the other pipe section can often provide a suitable ground connection.

Care must be taken when using an earth stake as the resistance is often not low enough. The stake must be positioned at least 45 M /150 feet from the pipe to ensure an even current distribution.

Using portable transmitter to provide locate signal

It is sometimes helpful to use a portable transmitter such as the RD433 HCTx2 to provide a better location signal, if the ELF signal from the PCM transmitter is insufficient.

- Very long distance from PCM transmitter.
- Locating distribution pipes from buildings where isolation joints are fitted.

The portable transmitter can be connected to the pipeline/network at a test point or isolation joint using LF, Low Frequency (512/640 Hz). The PCM transmitter should not be set to the LF frequency. Both connection and induction may be used for 8kHz.

PCM 4Hz measurements can be taken if the PCM transmitter is switched on.

Pipeline Current Mapper User Guide

Section 1

PCM transmitter to pipeline connections using Cathodic Protection Rectifier.

Single rectifier providing impressed CP current to single pipeline.

Rectifier is connected to anode and pipeline. Power supply from 110/220V AC mains.

Disconnect both cables for pipeline and anode from the rectifier terminals.

Failure to disconnect cables from rectifier will cause unstable PCM signals, and may cause possible damage to the PCM transmitter.

Connect PCM transmitter to the cables, White lead to pipeline cable, Green lead to anode cable. Use the mains power supply for the transmitter.

If Isolation Joints are not used PCM signal will be present in both directions from the connection point.

Single rectifier providing impressed CP current to multiple pipelines.

As above, disconnect pipeline and anode cables from rectifier.

Try to identify individual pipeline cables if they can be separated at the rectifier, so that each pipeline can be surveyed individually. This allows the maximum range to be surveyed.

Connect the white PCM Transmitter lead to one of the pipeline cables, and the green connection lead to the Anode cable. Use the PCM receiver to help identify the cables to the individual pipelines.

If the PCM transmitter signal is applied to more than one pipeline at a time, the signal will be divided between them, so the maximum range will be reduced.

Note; The pipe section which needs the most cathodic protection current will also have the most PCM current, so using the PCM receiver to measure the current on all the pipe sections fed from the rectifier will indicate the section with the worst CP faults. This is a quick and easy guide to coating quality.

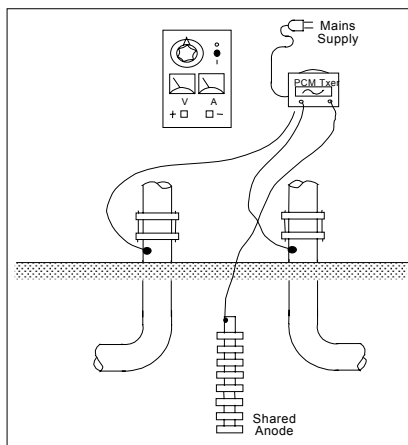
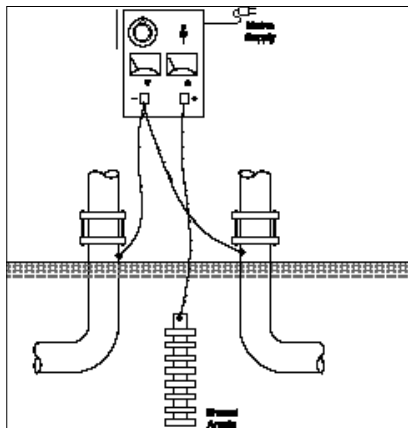
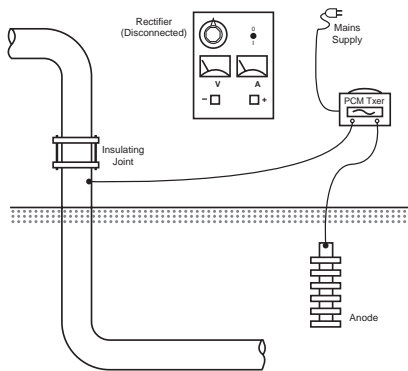
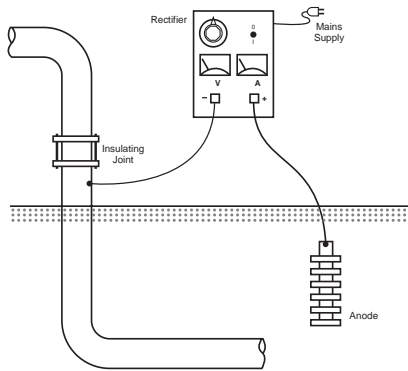

Pipeline Current Mapper User Guide

Section 1

PCM Transmitter to pipeline connections when rectifier is not available.

Test Points.

At some test points there are Isolation Joints with cables to the surface.

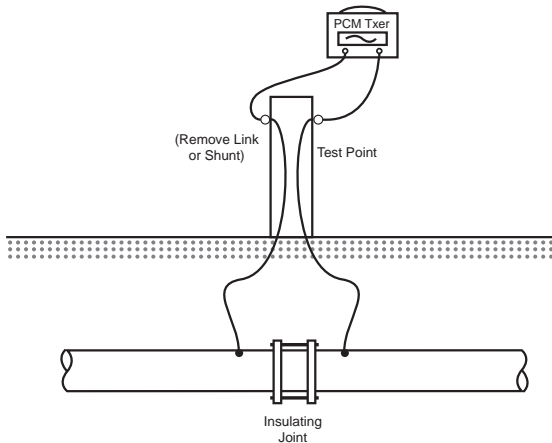
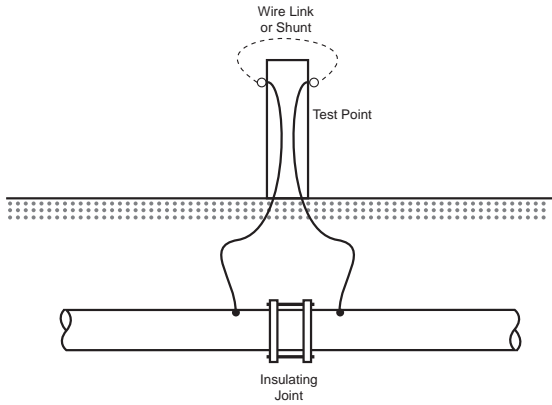

Connect the PCM transmitter across the Isolation Joint. White cable to the side of the pipeline that you want to survey, Green cable to the other side for ground.

Note: Make sure that the pipes run in opposite directions, If your connections are on pipes in the same direction this may effect the survey results.

Sacrificial Anodes.

Sacrificial anodes can be used as a grounding point for the PCM transmitter, and this type of connection can be used when there are no Isolation Joints.

Note. Some sacrificial anodes are connected directly to the pipeline and not linked to test points. These can be easily located as they cause large PCM current loss.

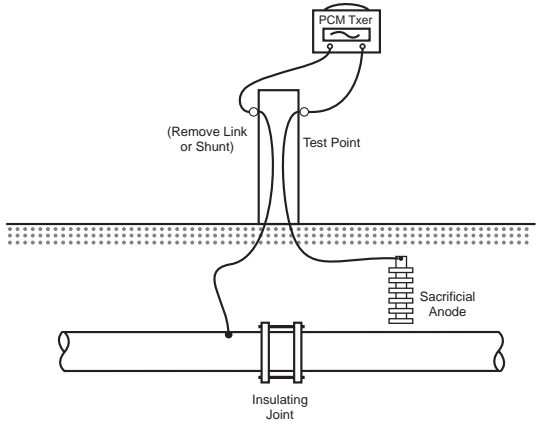
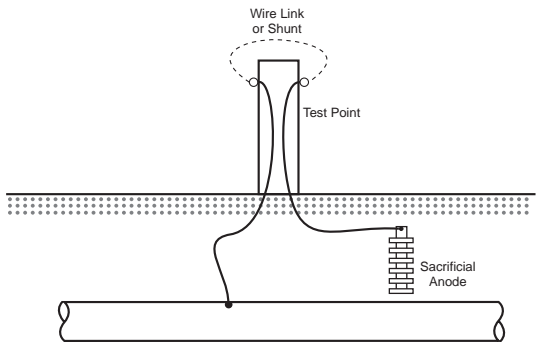

Disconnect the link wire from pipeline to sacrificial anode in the test point. Connect the White cable from the PCM Transmitter to the pipeline connection, and the Green cable from the PCM transmitter to the anode.

Note: If the Anode is heavily depleted it will be high resistance, and the PCM transmitter signal lights will indicate higher voltage.

In this case it is advisable to use a series of long ground stakes to provide low resistance grounding for the PCM transmitter.

Pipeline Current Mapper User Guide

Section 1

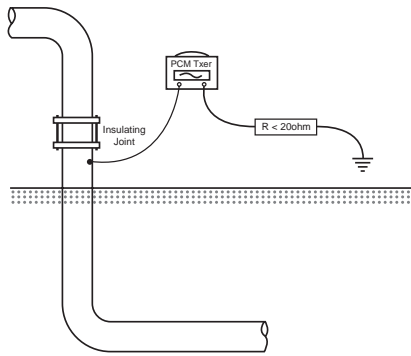

Whatever grounding is used for the PCM transmitter, it should have resistance less than 20 Ohms to ensure good current output from the transmitter.

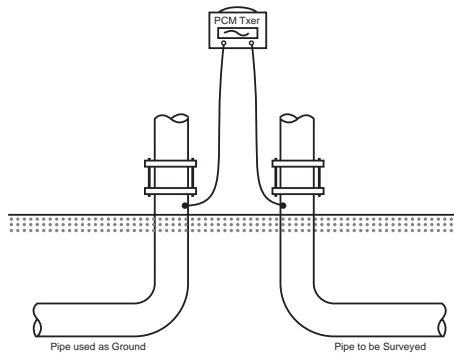

Using another pipeline as a ground for the PCM transmitter is an effective way of applying the signal.

Note: Make sure that the other pipeline runs in a different direction from the pipeline to be surveyed.

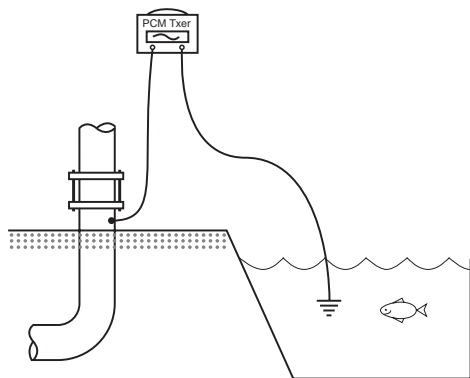

Streams, drainage ditches, dykes, marshes, or any mass of water can be used to ground the transmitter.

Connect the Green lead to any large metal object and submerge it in the water.

Note: Make sure that the pipeline is not running through the same wet area.

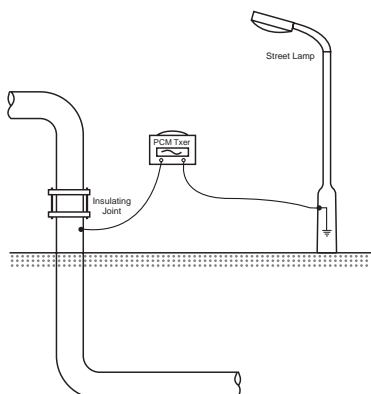

Other electrical fixtures can be used to ground the PCM transmitter. However this will cause all electrical cables in the area to carry the PCM transmitter signal.

If these cables run near the pipeline, they may affect the survey results.

Pipeline Current Mapper User Guide

Section 1

PCM Transmitter Power Supply Connections.

Switch transmitter OFF before connecting to either:

- 230 V (110 V) AC supply
- 20-50 V DC source
- 15-35 V rectified source

230 V (110 V) AC Supply or Generator.

Warning
The equipment must be earthed through the plug.

The transmitter is rated at 300 W at 230 V AC 50 Hz (110 V AC 60 Hz)

Connect the mains power lead to the rectifier, or use 230V (110V) generator that provides 300W or more for the transmitter to operate at its maximum output capacity

Vehicle DC to AC Inverter

Power supply from a vehicle DC to AC inverter which provides 300W or more at 230V (110V) from 12/24V DC, can also be used.

DC Supply

This allows the PCM Transmitter to be powered from 2 X 12V or 1 X 24 V auto batteries, and the output from the rectifier to the pipe and anode.

20-50 V DC and 15-35V rectified AC supply

The input voltage range is 20-50 V DC (14-35 V rectified AC). The current drawn from the supply will be a maximum of 5 A.

Ensure that the rectifier is switched off.

Then connect the black lead to the negative supply and the red lead to the positive supply, and switch the receiver on.

If the supply cannot provide 5 A, this will be indicated by the power limit warning light.

Turn the six position Current Select switch to the minimum position and switch on the PCM transmitter. Progressively increase to obtain a current output setting which does not overload the input.

Maximum output power is dependent upon voltage. For example, on a particular pipe an input voltage of 20 V may only allow a maximum output of 300 mA, whereas an input voltage of 50 V may allow an output of 3 A.

The transmitter DC input is protected against reverse polarity and over-voltage, and will not operate unless connected correctly.

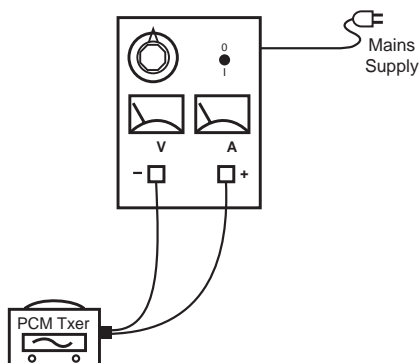
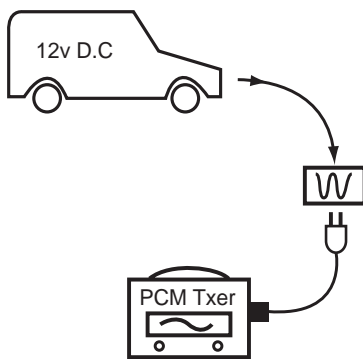
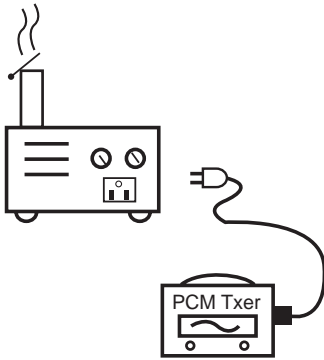

Pipeline Current Mapper User Guide

Section 2

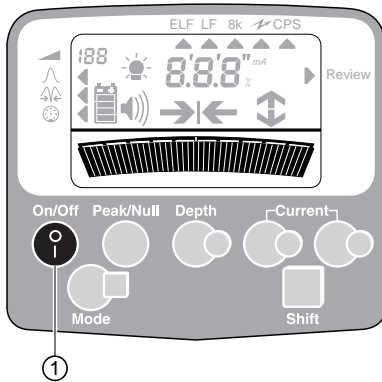

PCM Receiver Functions

On/Off (1)

Press for On and Off. If no control key is pressed for 5 minutes an audible beep warning is sounded. The PCM will automatically shut off 30 seconds after the warning. Pressing any of the operator keys will reset the automatic power-off timer.

When the PCM is switched off, it automatically saves the operating settings for the next start up.

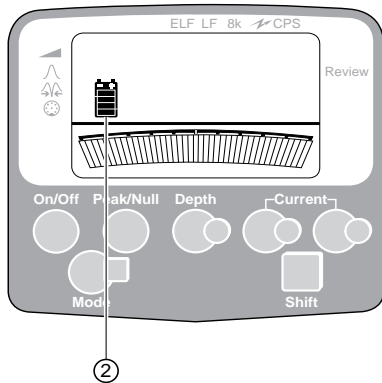

Batteries (2)

Display provides 4-level continuous indication of battery status. When battery replacement is necessary, display shows flashing battery symbol and 'Lo bat'. The expected battery life with normal use is 20 hours.

To replace batteries unscrew the battery compartment cover and insert 12 x LR6 (AA) Alkaline or Ni-Cad batteries.

Note:

When installing batteries always observe the correct battery polarity as indicated on battery holder.

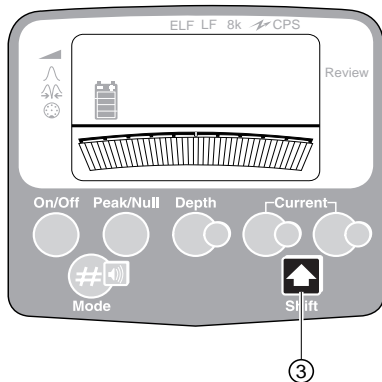

Shift Key (3)

Use the Shift key to access 3 secondary functions on the following keys:

Shift + Mode Key (4) Sound level.

Hold down the Shift key and press the mode key (#) to increase, decrease or silence the sound output.

Sound level is displayed on speaker volume icon.



Warning

To avoid possible injury, always test the audio level prior to using earphones.

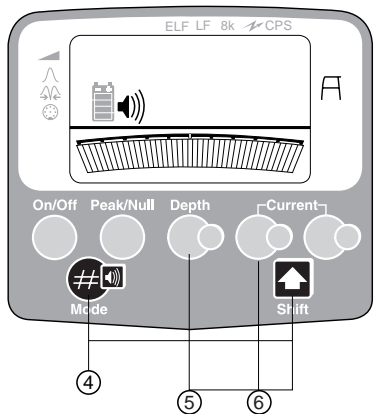

Shift + Depth Key (5) Saves data from Accessory A Frame Fault Find when this is connected.

Shift + Locate Current Key (6)

Datalog erase (only when in the Datalog Review Mode and the PCM magfoot is fitted).

Pipeline Current Mapper User Guide

Section 2

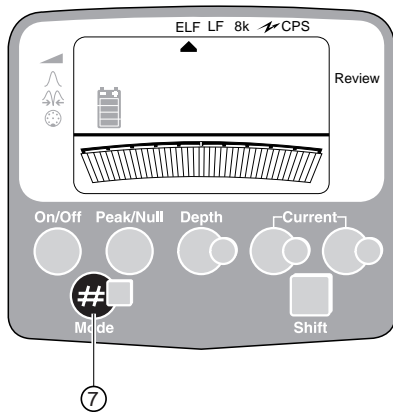

Operating Frequency - Mode (7)

Press the Mode key (#) to move through the choice of operating frequencies - modes available.

Mapping Modes

ELF Extra Low Frequency 128 Hz/98 Hz

LF Low Frequency 640 Hz/512 Hz

8 kHz Standard locate frequency from battery powered Radiodetection transmitters.

Current Direction arrows are displayed only with the PCM measurement, and not in locate modes, unless the PCM is supplied with CD frequency.

Extra Locate Modes

 Detects 50 Hz/60 Hz from power cables.

CPS Detects 100 Hz/120 Hz ripple from CP transformer rectifier.

Review Mode

Review Allows information stored in the data log to be accessed.

A Frame Indicates when Fault Find Accessory A Frame is connected.

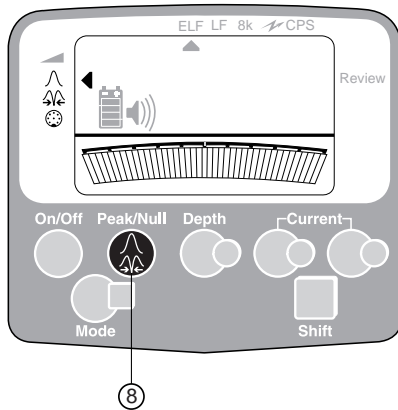

Peak/Null (8)

Used to pinpoint target line. Press to select either Peak or Null response. The pointer indicates selection. Peak and null locate modes are shown in basic location technique section 3.

Note:
Peak is the preferred method.

Left/Right Indication (9)

Indicates direction to pipe centre in Null mode. This is useful for fast pipe tracing and checking for interference.

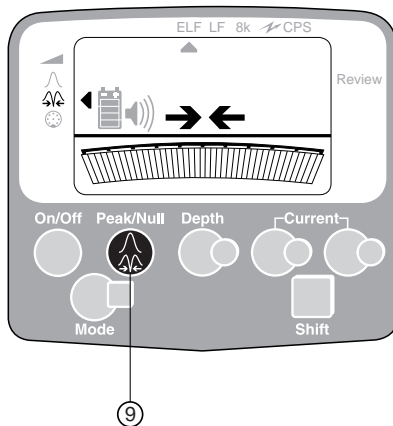

Accessory Socket (10)

Peak/Null key can also be used to select accessories that have been connected to the PCM via the plug on the back panel. The icon indicates that the accessory has been selected. This selection is automatic with some types of accessory.

Note:
The PCM magnetometer foot will be disabled if an accessory is connected.

Example accessories are:

- External antenna – Ask Radiodetection
- A-Frame – See section 7, Page 30-32

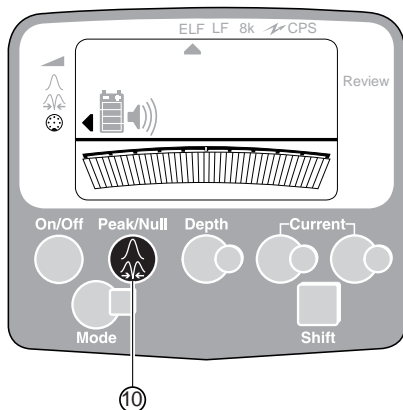

Pipeline Current Mapper User Guide

Section 2



Touch Gain Control and Bargraph (11)

Turn gain paddle clockwise or counter clockwise to increase or decrease PCM gain level. Actual PCM dB gain level (0 to 100) is displayed next to gain symbol top left of the LCD. The lower the gain reading, the stronger the signal source.

Signal strength is shown on the bargraph. The numerical display shows the bargraph percentage.

If bargraph indicates full scale, the numerical display indicates 99.9, touch the gain control once counter clockwise to reduce to 60% of full scale.

Note: Gain control paddle operates by small angular touch turn, and NOT full rotation.



Depth (12)

Once the target has been pinpointed press to display the distance between the bottom of PCM blade or attachment and the center of the pipe.

Depth measurements are displayed as follows:

Less than 1 Metre, depth displayed in cm.
Greater than 1 Metre, depth displayed in M.cm
Less than 3 feet - distance is displayed in inches.
Greater than 3 feet - distance is displayed in feet.

Note: To obtain accurate depth measurement the PCM must be directly over pipe with the blade at right angles to the target.

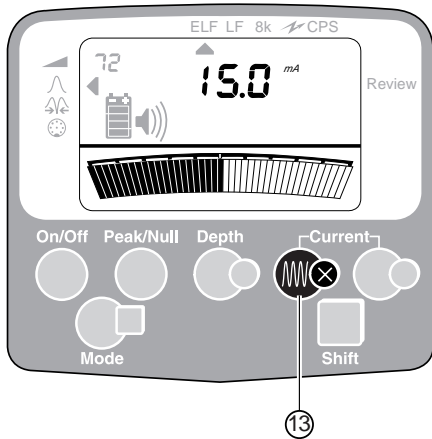

Locate Current (13)

Press once to obtain current value (mA) of locate signal when directly over pipe.

Note: This is the locate current, not the PCM current.

Locate Current is available in the ELF, LF and 8kHz frequencies.

Locate current is also available in CPS mode, except PCM model versions -CO and -CP. Not available in 50/60 Hz Power modes.

Pipeline Current Mapper User Guide

Section 2

Current Direction CD

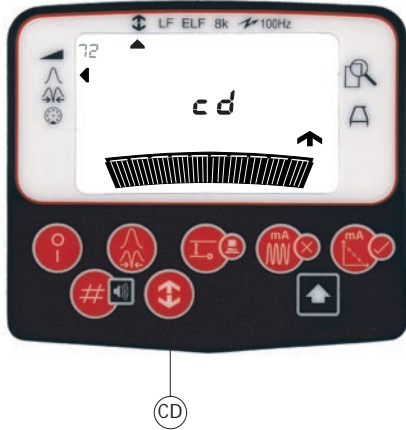

Keypad of PCM version – CT uses extra key “CD”. This uses 320/640 Hz CD signal from standard Radiodetection transmitter types RD433 HCTx, RD433 HCTX2 and PTX-3 providing CD output.

Current Direction arrows identify pipeline in locate mode frequencies.

Locate the pipeline and touch CD key. CD arrows on the display will point away from transmitter on correct pipeline and towards the transmitter on the wrong pipeline. Analogue Bargraph should be 100% scale or near 0% on the scale.

To exit CD and return to normal locate mode, touch the CD key.

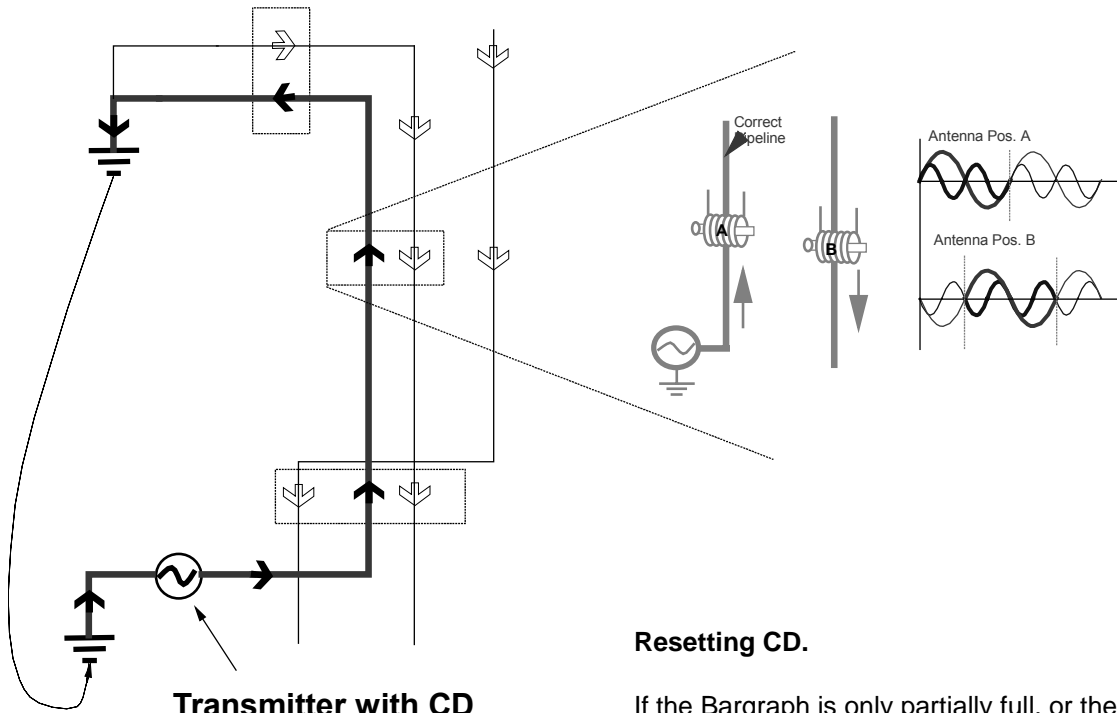

Transmitter with CD signal

Resetting CD.

If the Bargraph is only partially full, or the arrows are unstable, reset CD.

Set the PCM on the ground in CD mode, facing along the pipeline away from the transmitter (the user’s back towards the transmitter). Touch and hold Shift key and touch CD key. The display will show “rSt”, and then “SEt”. The arrow will point away from the transmitter and the Bargraph display will be 100%.

To change the direction of the CD arrows, repeat the Reset process above with the PCM facing the transmitter direction.



Pipeline Current Mapper User Guide

Section 2

STEPS IN PIPELINE CURRENT MEASUREMENT

When a PCM reading is taken and saved, the datalogger in the PCM magfoot will store log number, PCM current in mA, and dB, current direction and depth.

PCM Magfoot Attachment

Two types of PCM Magfoot are available, and can be identified when they are connected to the PCM Receiver.

The standard Magfoot has 100 datalogs, and the Magfoot2 has 399 datalogs.

When the standard Magfoot is connected the receiver will beep and the top left corner of the display will show "Pc".

The central digital display will show "100". Magfoot2 will also beep and show "Pc" on connection. The central digital display will show "399".

Pipeline Current Measurement (14)

See PCM receiver use section 3.

Note: This function is only available when the magnetometer foot is attached to the PCM.

To achieve accurate results the receiver must be kept as still as possible during this countdown.

Press once to initiate PCM current measurement. The LCD will indicate the letters 'Pc' and in the top left hand corner a 4 second countdown will commence (i.e. 04-03-02-01-00).

Measurement Cycle

After 4 seconds the measurement cycle is complete. The PCM current reading, direction arrow and next available log number are displayed until the acceptance or rejection buttons are pressed.

If 'rPt' (repeat) is displayed take the reading again.

Note: A flashing reading means reading is marginal and should be taken again. This may be caused by moving metal or nearby vehicles.

Note:

If the Magfoot2 with 399 datalogs is used, datalog numbers from 1-99 will be shown in the top left hand corner of the display. Datalog numbers from 100-199 will be indicated by the addition of a flag by the Peak mode indicator. Datalog numbers from 200-299 will be indicated by 2 flags against the Peak and Null mode indicators. Datalog numbers from 300-399 will be shown by 3 flags against the Peak, Null and Accessory indicators.

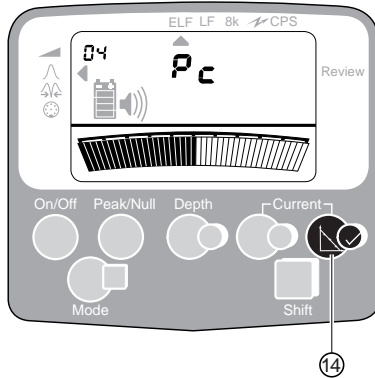
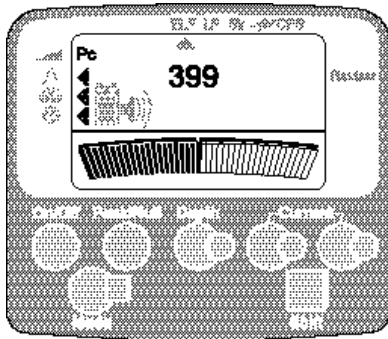
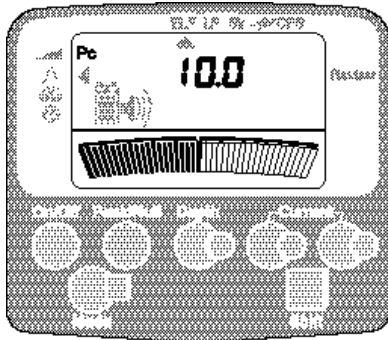

Pipeline Current Mapper User Guide

Section 2

Saving or Rejecting PCM Current Reading (15)

Once a PCM current reading has been obtained a log number (1-100 or 1-399) is shown in the top left hand corner of the screen. This is the log number that will be used if the reading is saved.



Press ✓ to accept - displays 'SAV' and returns to locate mode.

Press X to reject - returns to locate mode.

Overwriting previously stored results.

Previously stored measurements can be overwritten. Use the gain paddle to select the required log number before pressing the acceptance (✓) button.

Review mode (7)

To review previously stored data, attach the magnetometer foot to the PCM. Use Mode key (#) 7 to select review mode.

The LCD will show "Log", then the most recent log number will be displayed at the top left corner of the LCD. The mA value of the PCM result and the current direction arrows will be shown on the LCD.

Use the gain paddle to step backwards or forwards through the stored data logs.

If the datalogger is empty "no LOg" will be shown.

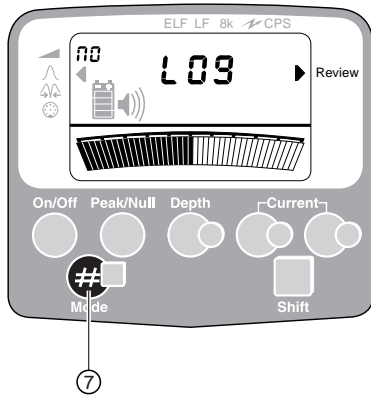

Pipeline Current Mapper User Guide

Section 2

Upload (16)

Note: Radiodetection upload software is required on the target PC. See PC Software section for further details.

With the magnetometer foot attached and the unit in Review mode stored datalogs can be uploaded to a PC. Use the full 9 pin D-type RS232 serial cable provided with the PCM to connect the PCM Receiver to the PC.

Press the Depth key and 'uLd' is displayed.

Data stored in the receiver is not erased until confirmation is received from the PC. With Upload software version 32 user can select if log data is erased or retained. (See PC Software section 11 page 41)

Upon successful completion the data is erased from the PCM and "cLr" followed by "no Log" is displayed.

Note: Using PCM32 Download Software the user can choose to copy data to PC, and not to erase stored data. Please refer to software section 11.

Erase All Stored Datalogs (6)

While in the Review mode the entire log can be deleted. To prevent accidental erasure both the Shift and Locate Current keys have to be pressed simultaneously.

Displays 'cLr' while erasing and 'no LOg' when empty.

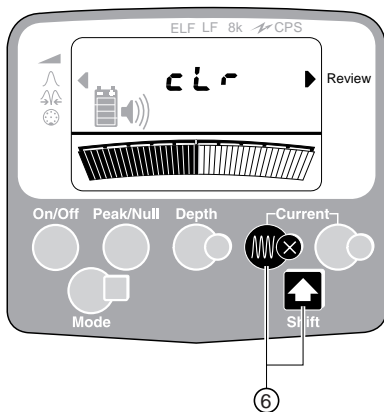
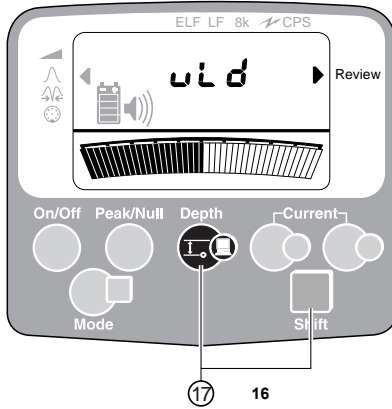

Pipeline Current Mapper User Guide

Section 3

PCM Receiver use, basic location technique

If the PCM transmitter is connected and switched on, use ELF or LF frequency. If no transmitter is connected use CPS frequency to locate 100/120 Hz from CP system.

Switch on the PCM receiver and use # key to select operating frequency to locate the pipeline.

Pinpointing a Target Line

Pinpointing defines the exact position and direction of a pipeline after it has been traced and its position is approximately known. Pinpointing is important as the depth and current readings are affected by misalignment error.

Peak Procedure

Adjust the PCM Receiver sensitivity to half scale. If bargraph is full, touch the gain paddle counterclockwise once, this will reduce sensitivity and bargraph to 60%. It may be necessary to adjust the gain during the procedure to keep the bargraph on scale.

- Hold the detection blade near the ground and with the blade vertical.
- Make traverses from side to side of the pipeline and define the point of maximum response.
- Turn the Receiver around as if it is a pivot. Stop at the maximum response and note receiver direction. Reduce sensitivity if necessary.
- Continue to rotate receiver until display shows zero response; the blade is now parallel with the pipeline, and this shows the exact direction of the pipeline. Rotate the receiver through 90 degrees. The response is now maximum.
- Move the Receiver gently from side to side to define the exact position of the peak response. The detection blade will then be directly over the pipeline and at right angles to it.

Mark the pipeline position.

Null Procedure

Follow the procedure for pinpointing with a peak response and mark the position.

Switch to null response and follow the left/right arrows. Note the position of the null response over the target.

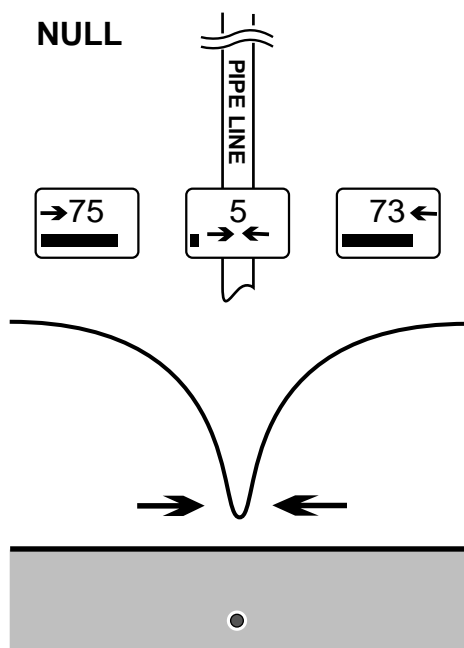
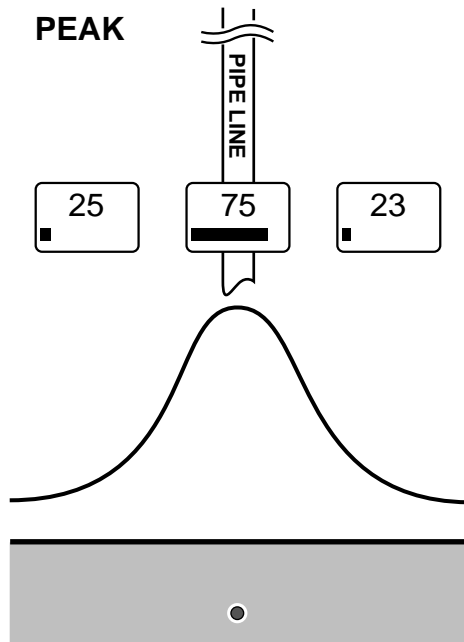

Pipeline Current Mapper User Guide

Section 3

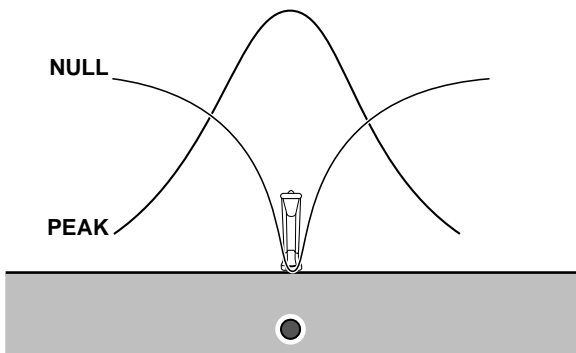

If the positions of the peak and the null pinpoint correspond, it can be assumed that the pinpoint is precise; If the positions do not correspond the pinpoint is not precise. Note that both peak and null pinpoints will show an error to the same side. True position will be close to peak position.

Accurate PCM results are only obtained when the Peak and Null positions are within 15 cm/6 inches of each other.

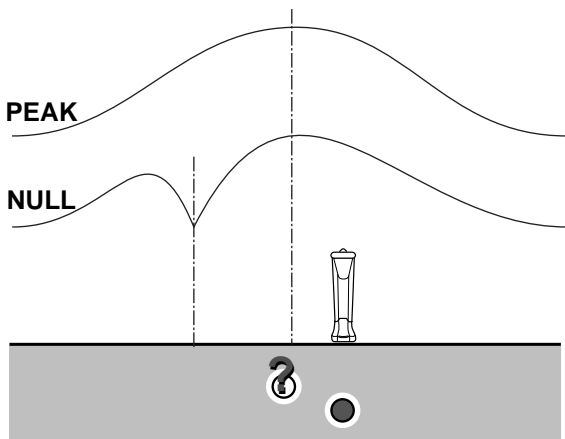

Effects of interference from parallel pipes and valves on the Peak and Null positions.

If Peak and Null locates are different by more than 15 cm/6 inches, assume that magnetic field is distorted and take PCM readings at a different position.

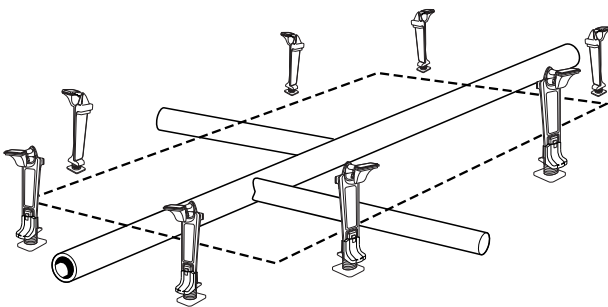

When searching for a service, 'Tie-ins' or 'L' then perform a box sweep of the area. Walk to the side of the pipe, turn the gain up until a 50% reading is obtained.

When walking around the box remember to keep the PCM receiver in position so that the blade is never in line with the pipe.

Pipeline Current Mapper User Guide

Section 3

Depth and Current measurements

When taking depth and current measurements, it is always important to position the PCM directly above the pipeline and at 90° to it.

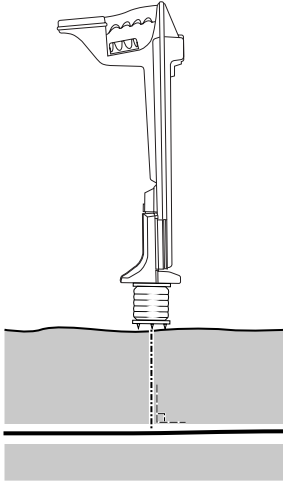

Pipeline depth measurements can be taken in all of the location frequencies except 50/60Hz Power frequency.

Current measurements can be taken in the ELF, LF and 8kHz location frequencies.

PCM versions - CR, - CS and - CT will also provide current measurement in the CPS frequency.

When the PCM magnetometer foot is attached to take PCM readings, make sure that the PCM magfoot arrow is pointing along the direction of the pipeline.

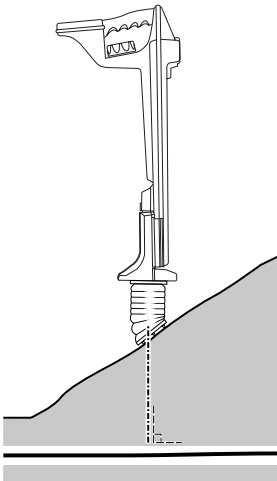

On a slope the attachment allows a certain degree of adjustment to help maintain this position.

Try to flatten the ground to allow PCM magfoot to be parallel to the pipeline.

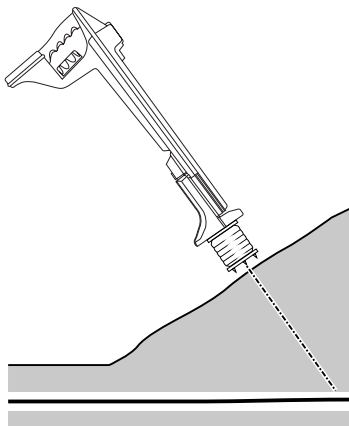

Incorrect depth and current measurements will be obtained if the receiver is held at this angle.

Do not take readings like this.

Note: Accurate PCM results rely on accurate depth measurement. As magnetic field distortion is likely at T's, junctions, bends or depth changes of the pipeline, try to avoid taking PCM measurements above these points.

Pipeline Current Mapper User Guide

Section 4

Current Mapping Theory

Current Measurements – Obtaining and understanding results

A current flowing on a buried conductive structure produces a magnetic field directly proportional to the magnitude of the applied current. By resolving components of the magnetic field from above surface the original current can be precisely determined.

At the heart of the PCM system is the current mapping near DC signal applied by the transmitter. A pipeline's electrical characteristics of current attenuation and distribution at this very low frequency (4 Hz) signal are virtually the same as they are for the Cathodic Protection current from the rectifier.

The PCM receiver contains a precision, high performance sensor known as a magnetometer which remotely detects and measures very low frequency magnetic fields. Advanced signal processing technology provides push button current measurement (and direction) of the near DC (4 Hz) signal and a datalogging function enables graph of current loss against distance to be plotted after downloading to PC.

In all diagrams the arrows indicate the direction of current flow to the transmitter. Their relative size reflects the magnitude of the current.

The PCM transmitter applies a current to the pipeline and this current reduces in strength as the distance from the transmitter increases. The rate of reduction depends on the condition of the pipe coating, ground resistivity and pipe electrical resistance.

The PCM receiver compensates for depth changes during current measurements, and current readings remain constant even when the depth of the pipeline changes.

When a fault is encountered the current quickly drops. A fault will result from coating damage, contacts with other services, etc. The loss of PCM current will be virtually proportional to the amount of CP current being used at the fault.

Note: Linear current loss may naturally occur along the pipeline due to the age of the pipe and coating conditions.

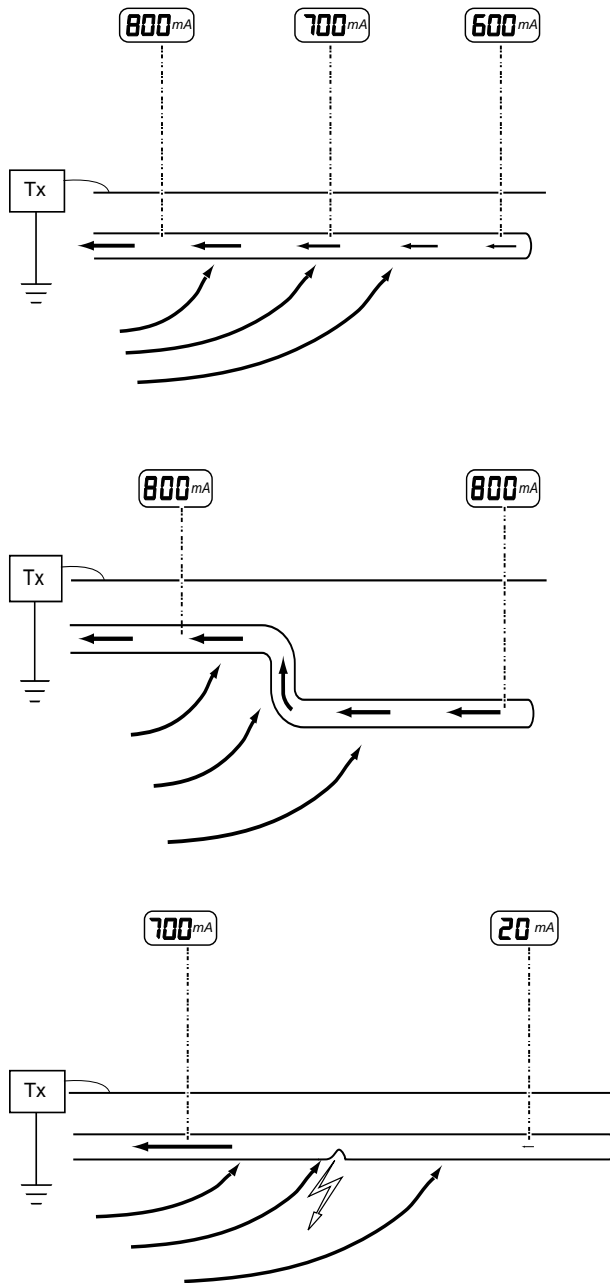

Pipeline Current Mapper User Guide

Section 4

Using dBmA for Pipeline Current Mapping.

The PCM receiver can display current as amps/mA or dBmA, and when results are saved to the internal datalogger, both mA and dBmA are stored in the memory.

To change the PCM display current from mA to dBmA, please see method in section 10 page 37.

The AC signal current applied to a coated pipeline in perfect condition will be lost by capacitance as distance increases from the point where the signal is applied. The PCM uses near DC signal (4Hz) for current measurement, so capacitive losses are minimal. The resulting graph drawn using A/mA will have an exponential slope, because there is a greater current loss rate close to the transmitter.

Converting the exponential mA result to logarithmic dBmA will show the same graph as a straight line slope.

Displaying the results using dBmA loss per distance has the advantage that the resulting graph is easier to analyse.

Example; There was a coated pipeline which had three defects of equal electrical resistance, one near the beginning, the next in the middle and one at the end. If the current loss graph is prepared using mA on the vertical scale the second and third faults would be shown as progressively smaller steps in the graph. This is due to Ohms law, and the loss of current at the previous fault.

Using dBmA as the vertical scale would result in equal steps in the graph for equal size faults, regardless of how much current was lost at the first fault.

The graphs below show three equal faults and the effects on a graph showing mA and dBmA.

Note that the graph showing mA at first glance suggests that the faults are of diminishing magnitude. The graph showing dBmA clearly shows the magnitude of the faults are equal. Therefore dBmA shows the ratio of the faults, whereas mA alone may give rise to misinterpretation of data due to the high current loss near the transmitter and lower losses further away.

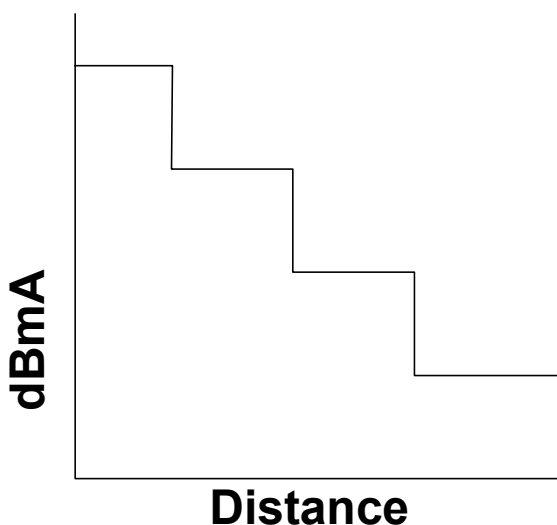
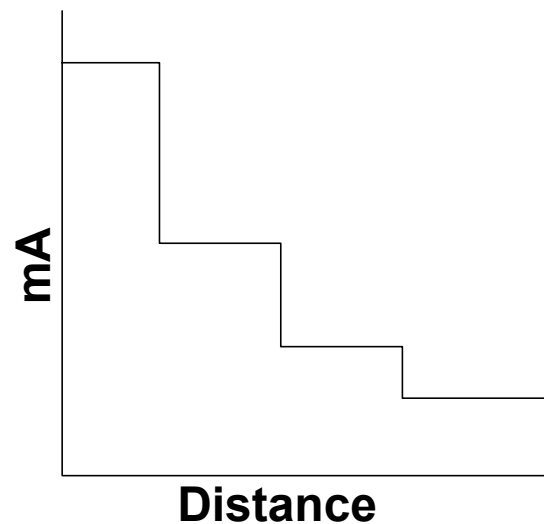
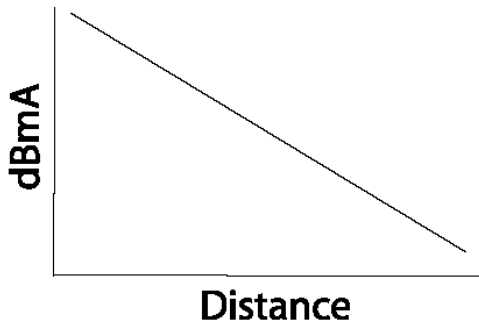
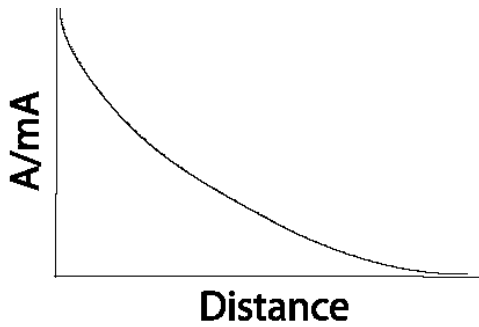

Pipeline Current Mapper User Guide

Section 4

Graph 1:- The line marked "A" to "E" is the data collected, whilst the line "1" to "4" is the interpreted data.

Note that at position "A" the current falls and then returns to almost its original level. This is probably due to field distortion of the locate signal possibly caused by another utility line above the pipeline and should be ignored or further investigation undertaken.

Steps "B" to "E" show definite steps (with some field distortion at the point of fault) and loss of signal. Note the recovered reading is less than the signal before the trouble.

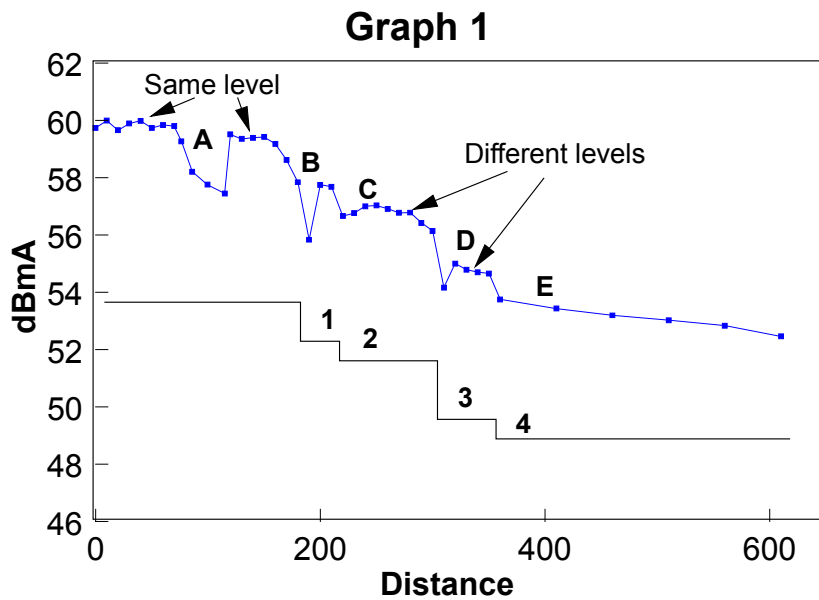

Further investigations using the PCM A-Frame should now be undertaken so as to pinpoint the exact position of the faults.

Pipeline Current Mapper User Guide

Section 5

TAKING MEASUREMENTS – Pipelines and Distribution systems – Basic Technique

'Tie-ins' and 'L'

The current will be split between the two lines.

$$\text{i.e. } 800 = 700 + 100$$

The pipeline with the greatest reading indicates where the majority of current is flowing from and is the direction to follow in order to locate the fault (short or poor coating).

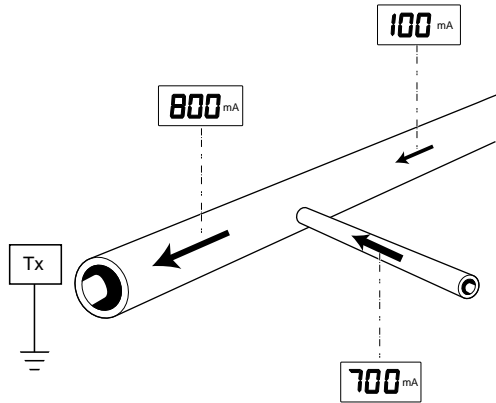

The current will be split between the three lines.

$$\text{i.e. } 800 = 600 + 150 + 50$$

The pipeline with the greatest reading indicates where the majority of current is flowing from and is the direction to follow in order to locate the fault (short or poor coating).

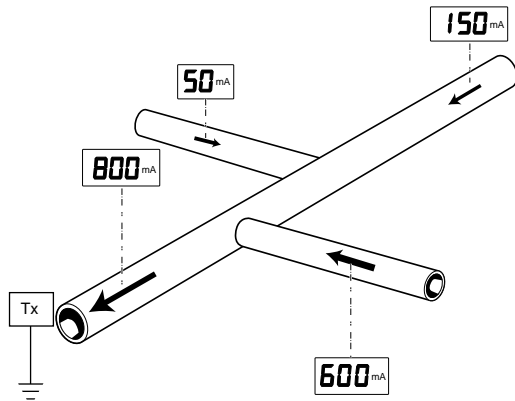

Loops

If the current arrow changes direction it could indicate the pipe has changed location. Use the PCM in Locate mode to relocate it.

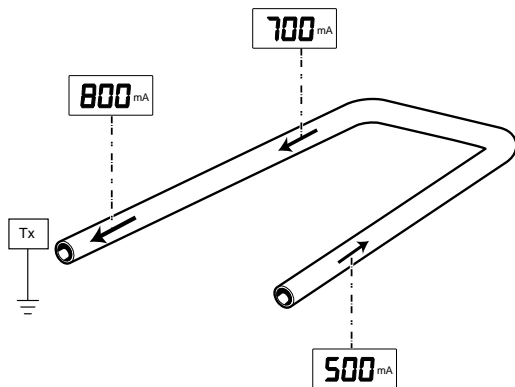

Current flow within a Loop system

If all distances and coatings are equal, and the rate of loss is constant, the current measured at Point A will be zero.

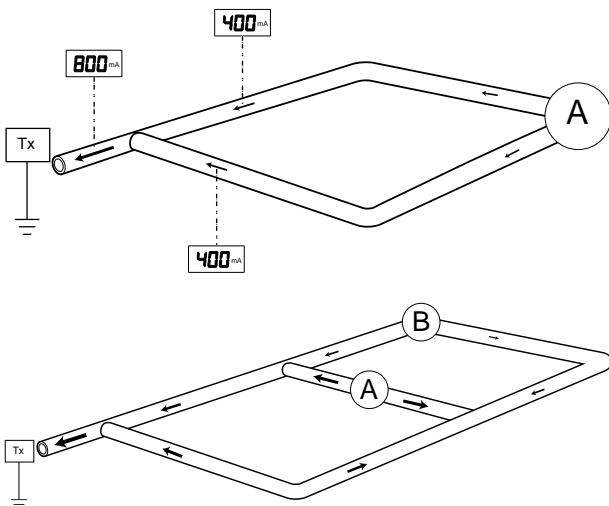

In practice, with pipes of different ages and coating the points reading zero (0) could be anywhere. The respective current readings will indicate the direction to follow.

Pipeline Current Mapper User Guide

Section 5

Taking Measurements – Distribution Systems.

Below are some typical results which can be found from using the PCM for CP system diagnosis on a distribution system.

Good local knowledge, and a map of the pipe network is essential to determine suitable positions to connect the PCM transmitter and where to take readings. It is worthwhile taking measurements over the complete site before concentrating on any particular area.

The following diagram is a typical street involving 'Tie-ins' and an 'L'. The readings from the PCM and distances to prevent interference have been included. By working around the map a short was quickly and easily detected.

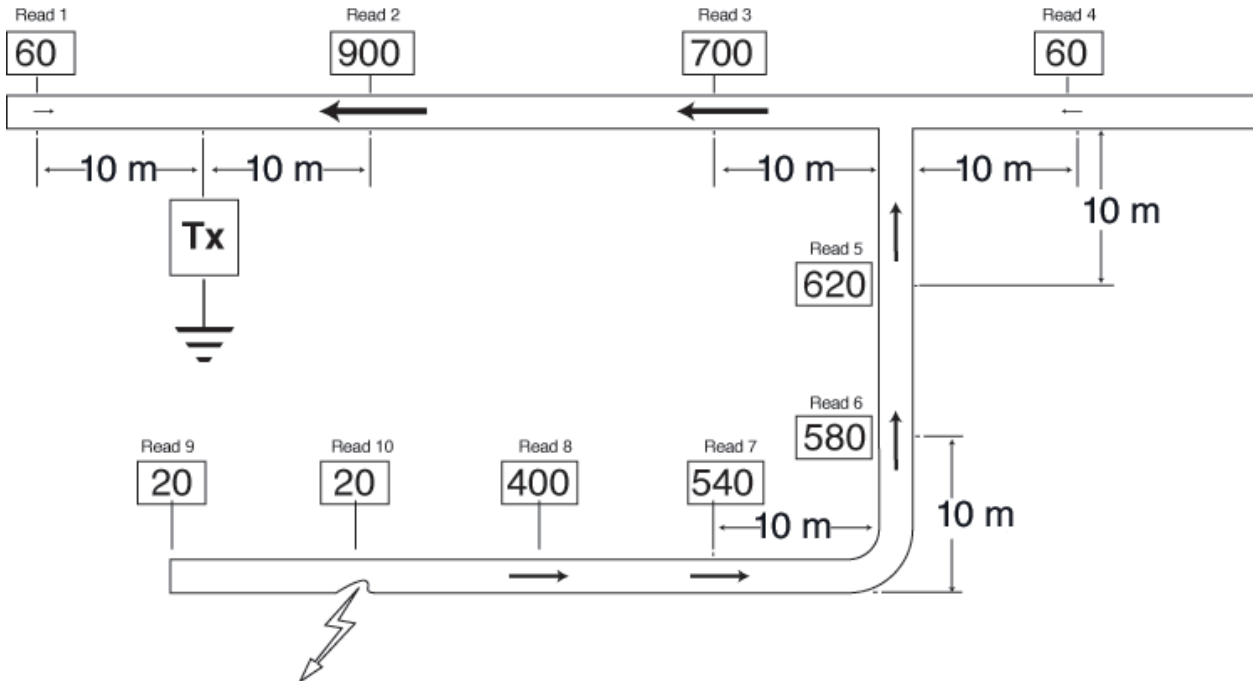

In this example measurements were taken at key areas to determine direction of major current flow.

Read 2 indicated initial direction to follow.

Read 5 indicated which section on tie-in to follow.

Read 9 indicated that the short had been passed and was between Read 9 and Read 8.

Short found by dividing the distance between a good and bad read until located.

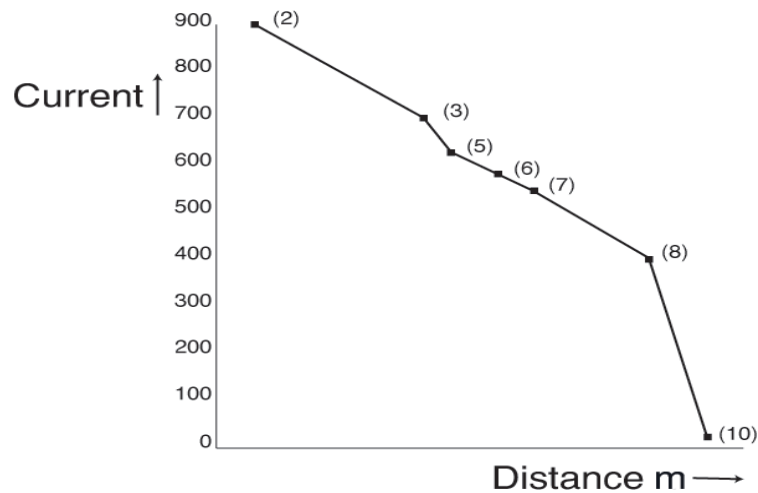

Pipeline Current Mapper User Guide

Section 5

Pipelines and Pipeline defects

Interpretation of Readings and Graphs

See Upload section 11, pages 39-43.
See Drawing Graphs section 12, pages 44-63.

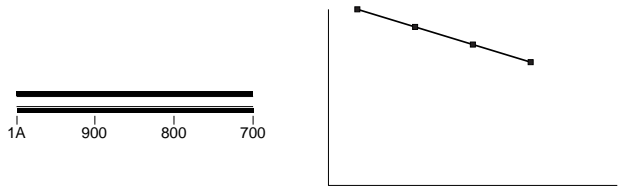

Pipe coating in good condition is shown as very little loss of current.

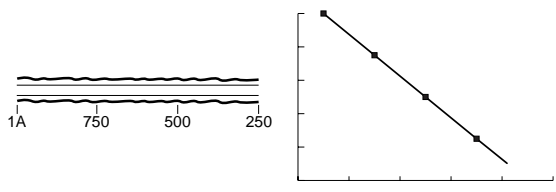

Pipe coating in poor condition is shown as a rapid loss of in current.

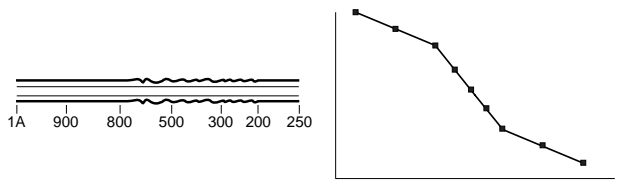

Mixture of good and poor coating which is shown as greater current loss over the section of pipe with poor coating.

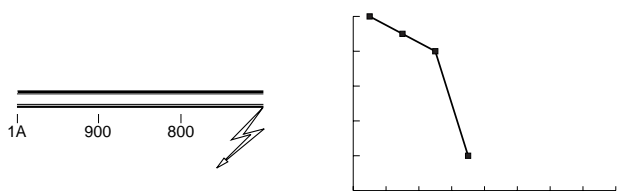

The effect of a short or contact with another service is a sudden current loss.

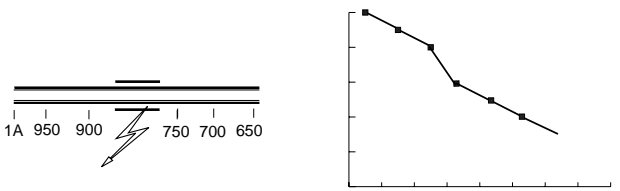

The effect of a poorly coated steel shield in contact with the pipeline is to show reduced current in one measurement section.

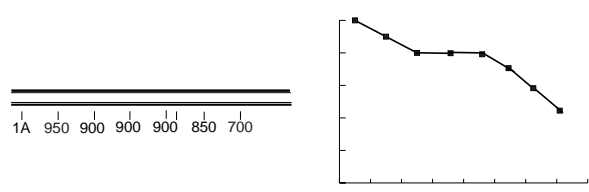

This effect is either a section of perfect coating or ground conditions that are shielding the signal – dry or rocky ground.

Pipeline Current Mapper User Guide

Section 6

Applications – Parallel Pipes

New distribution pipe with the old pipe running parallel and about 30 cm/10 inches away.

A 1 Amp signal was applied

To make the explanation easier the pipe has been divided into section A & B.

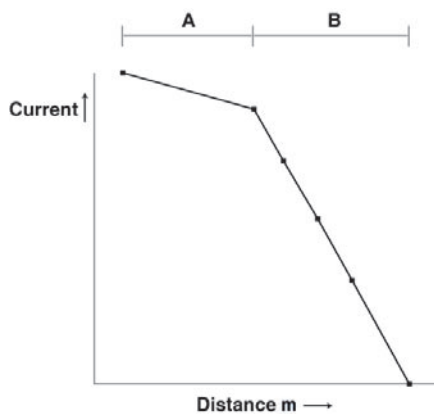
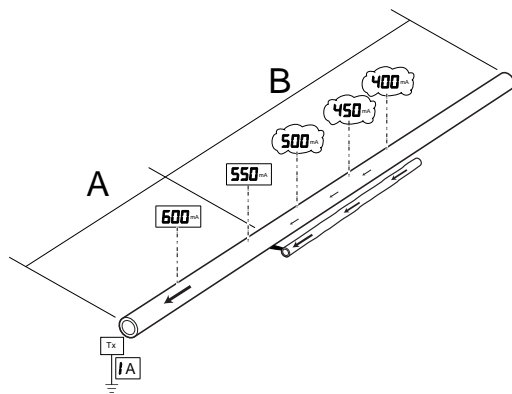

Section A Good peak and null locate, with peak and null locates in the same position. Results indicate a good coating on the pipe (600 and 550 mA).

Section B Poor peak and null locate shifted to one side from the previous alignment. Readings start to decrease rapidly.

In this case the old pipe had been shorted to the new pipe. The poor coating on the old pipe provided a good path for the PCM transmitter current.

This is indicated by the locate being offset to one side and the rapid decrease in current reading.

When plotted the graph illustrated this effect with the bend indicating the position of the short/contact.

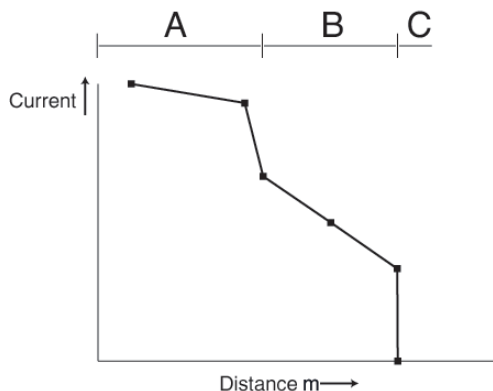
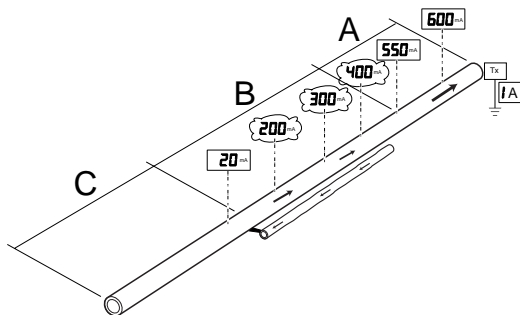

To verify the fault location the transmitter was repositioned to the other end of the pipeline and the following results obtained.

Section A Good Peak and Null locate, reading decreasing at a steady rate.

Section B Poor peak and Null locate with a sharp fall in current reading.

Section C Short/Contact.

The easiest path for the current to flow is down the old discarded pipe. As this is in the opposite direction to the flow on the new pipe it has a cancellation effect which accounts for the sharp drop in reading.

The short would be at the point where the current drops close to zero.

The graph is used to illustrate this effect.

Pipeline Current Mapper User Guide

Section 6

Typical application where a short piece of parallel pipeline interfered with the result.

For ease of explanation the pipeline has been divided into three parts A, B & C.

In this situation a 1 Amp signal was applied to the new pipeline and the direction of maximum current flow followed.

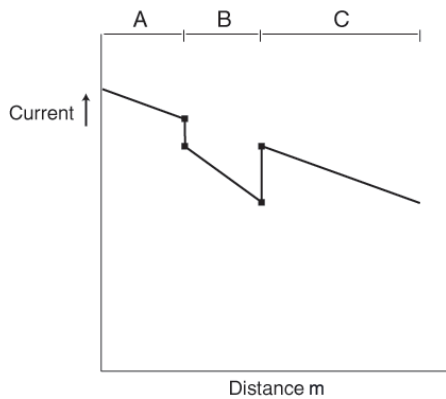
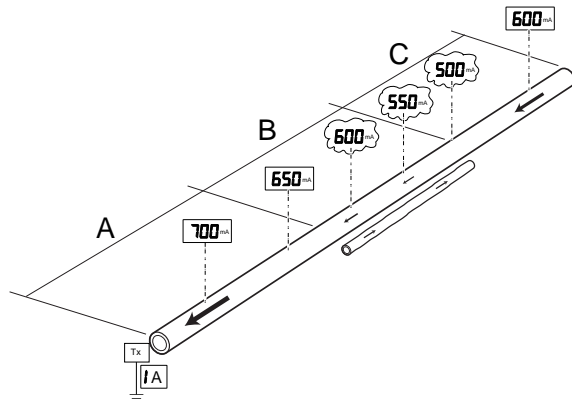

Section A Good Peak and Null locate and a steady rate of decrease that indicated a good coating.

Section B Poor Peak and Null locate (outside 15cm/6 in. requirement) and a significant drop in current reading.

Section C Good Peak and Null locate with a rise in current and then a steady rate of decrease.

Another service was found to be close to the new pipeline in Section B and had a small amount of current flowing in the opposite direction. This had a cancellation effect, which caused the current on the new pipeline to fall.

When plotted the graph illustrated this effect.

Survey on new pipeline where the current on one side of the transmitter flowed away from the transmitter.

The PCM transmitter was connected and a 1 Amp current selected.

A reading of 900 mA was detected on one side with the arrows pointing towards the transmitter.

The other side gave a poor Peak and Null with the current pointing away from the transmitter. Another reading was taken further away from the transmitter with the same result.

It was found that another service was shorted to the pipeline as shown and at some stage ran parallel to the new pipeline. The current on the new pipeline had no effect as it was so small compared to this other service.

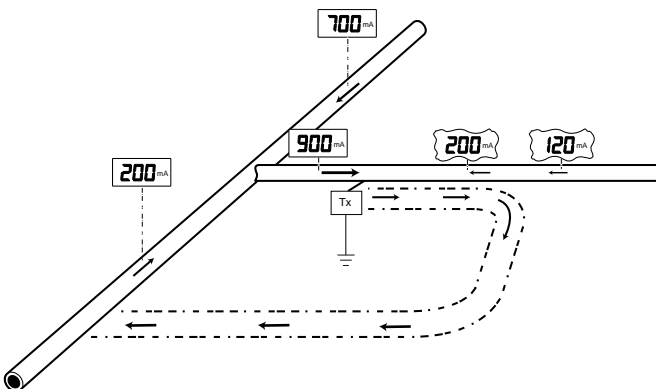

Pipeline Current Mapper User Guide

Section 6

Locating bonding cables between new and old pipelines by moving PCM Transmitter to both ends of a new transmission pipeline that had an older discarded pipeline running parallel and about 3 M /10' away.

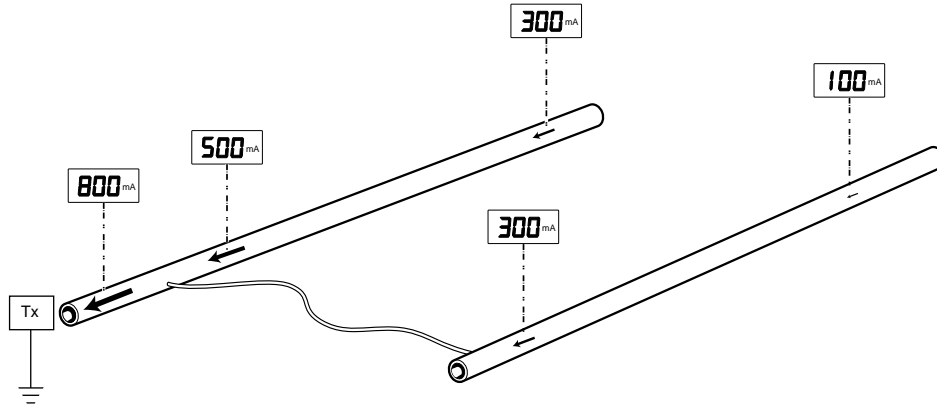

The PCM Tx was connected at a rectifier and a current measurement of 800 mA confirmed the direction to follow.

At a distance of about 3 Km/2 miles from the transmitter, two readings were obtained, 300mA on the new pipeline and 100mA on the old pipeline. The PCM current arrows pointed towards the PCM Tx indicating that somewhere within the 3Km/2 miles the new pipeline had been bonded to the old pipeline.

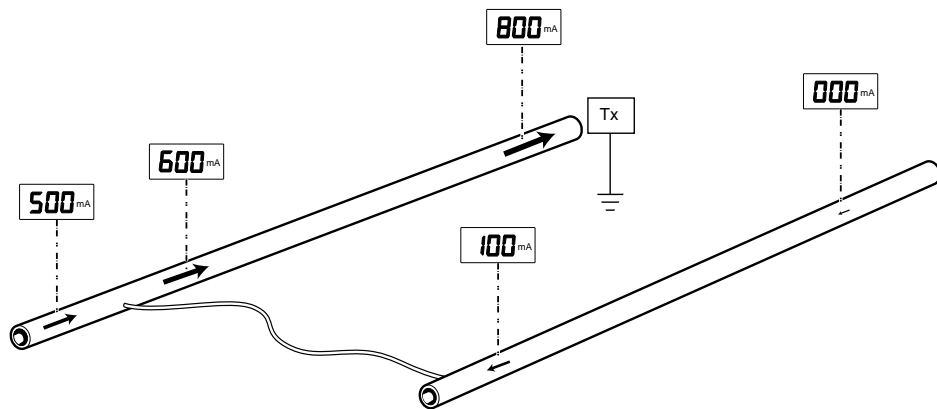

The Tx was then connected to the other end of the new pipeline and measurements taken at exactly the same positions. A reading of 800 mA was detected on the new pipe, but there was no reading on the old pipeline.

As a series of readings were taken on both pipelines closer to the point of bonding, current appeared on both pipelines and with the arrows in opposite direction. This indicated that the bonding point was further ahead.

The point of bonding was located, and a measurement of 500 mA, concluded that the other faults existed closer to the rectifier.

Pipeline Current Mapper User Guide

Section 7

Using the Accessory A Frame with the PCM.

Overview.

The accessory A Frame is used with the PCM receiver to precisely pinpoint coating defects and isolation faults.

- The A Frame spikes need to make good electrical contact with the ground, preferably with damp conductive earth.
- The PCM receiver display indicates direction to the fault, using the CD direction arrows, and this makes fault position easy to locate.
- The PCM also displays the dB microvolts reading across the A Frame spikes, and this allows a comparison to be made between different faults to determine the most severe. This numeric value can be stored in the PCM's second datalogging facility, recalled, and uploaded later to a PC.



Operation.

After obtaining PCM current loss results, decide which sections of the pipeline require Fault Find survey.

The PCM transmitter is connected and switched on, using frequencies of ELF with 4 and 8 Hz, or LF with 4 and 8 Hz.

PCM Fault Find readings can be taken with or without the PCM magnetometer foot connected to the PCM receiver.

Note: With the Accessory A Frame plugged in, it is not possible to take PCM Current readings.

- Plug the 3 pin connection lead into the A Frame, and the multipin connector into the accessory socket on the rear of the PCM Rx. The PCM Rx will beep, switch to the accessory socket position, and indicate a flag against the A Frame position on the PCM LCD label. The PCM LCD shows "FF". Use the "peak/null/accessory" key 8 to switch between locate and faultfinding.
- Locate the pipeline. Position the A frame above and in line with the pipeline, and the spike marked with Green tag away from the transmitter connection point, Red spike tag towards transmitter.

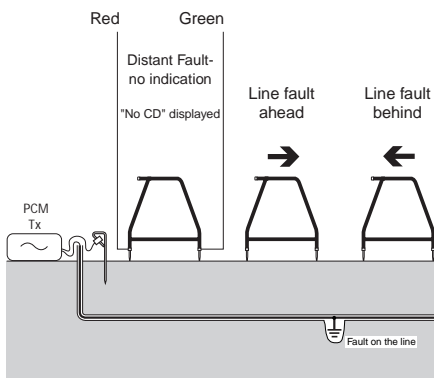
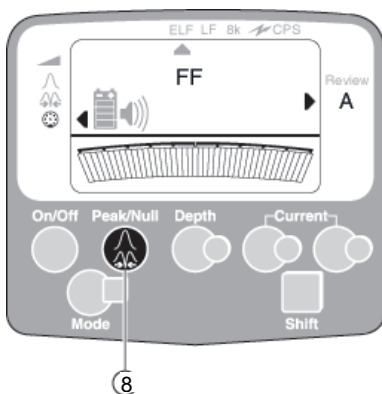

Pipeline Current Mapper User Guide

Section 7

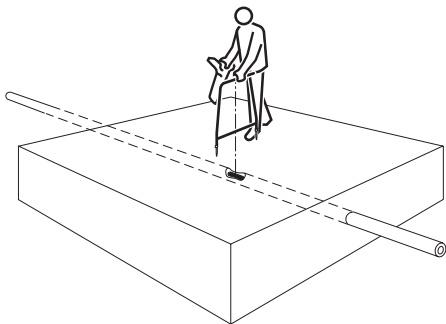
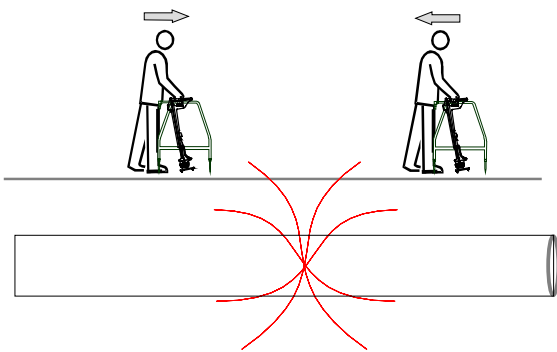
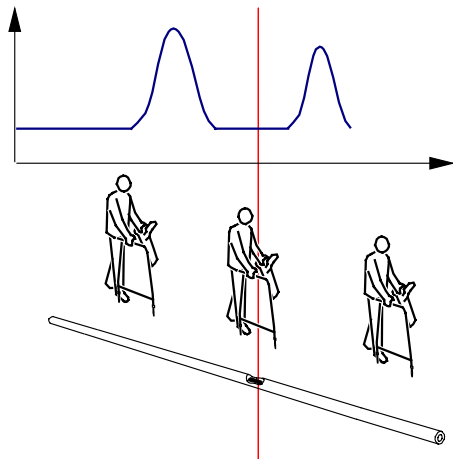
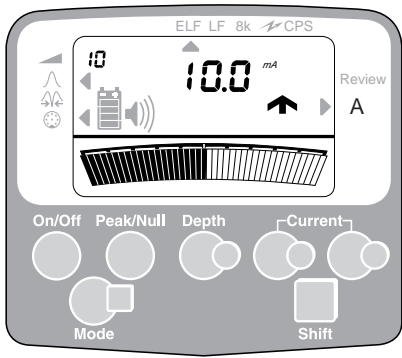

- Push the A Frame spikes into the ground to take a reading. It will then automatically adjust its signal level and calculate the current direction and the dB microvolt reading. Note that the gain numbers will flash during calculations. No user adjustment is necessary.
- Display arrows indicate PCM Transmitter current direction through the ground, for user convenience this is arranged to display direction to fault. If no arrows are displayed there is unlikely to be a fault close by, and there is too little current in the ground to activate the fault direction arrows, or by chance the A Frame is directly over a fault.

Make sure that there is good ground contact. Pouring a small amount of Water on a road surface will improve results.

The display also indicates the dB microvolt reading. If reading is around 30 or less, there is unlikely to be a fault nearby.

- Move further along the pipeline and make ground contact with the A Frame spikes again. When a new position gives CD arrow indication forwards, and the next gives CD arrow indication backwards, the operator has walked over a fault. A numerical dB microvolt reading of around 60 can be expected.
- Move backwards along the pipeline taking tests at 1 Metre intervals. See that the numerical dB microvolt reading value rises, briefly falls, and rises again, before gradually reducing. The CD arrows will also change direction either side of the fault point.
- Retest by taking small movements forwards or backwards until the position is found where the arrows just change direction, and the dB microvolt reading is lowest. This will confirm the fault is directly under the centre of the A Frame.

Turn the A Frame through 90 degrees so that it is now across the pipeline. Repeat previous stage. The fault point is now exactly under the centre of the A Frame.

Mark this point with a wooden stake or paint.

Continue along the pipeline section until all faults have been found and marked.

Pipeline Current Mapper User Guide

Section 7

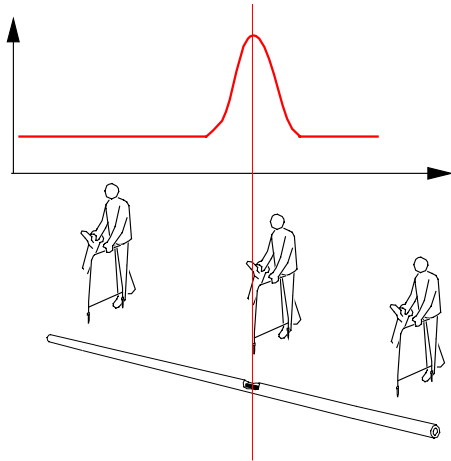

Comparing fault severity.

To determine the severity of the fault, and compare different faults on the pipeline to decide repair priorities, take the dB microvolt readings with the A Frame at 90 degrees to the pipeline.

Place one of the A Frame's spikes directly above the pipeline, and the other away from the pipeline. Start approximately 1 Metre from the fault position, testing at 25cm (or smaller) intervals. Note the highest dB microvolt reading, or save it in the datalogger and note log number.

At any time during the survey the user can switch to locating the pipeline using the "Peak/null/accessory" key 8, or pulling out the connection plug from the accessory socket on the PCM Rx, and taking current gradient readings.

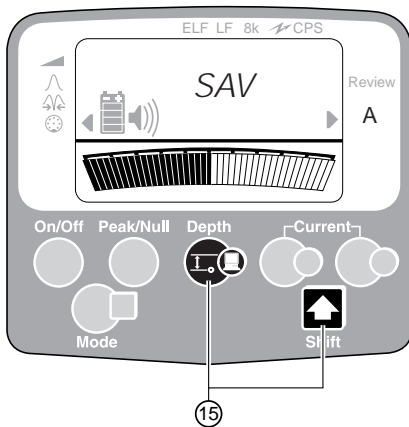

Saving PCM FF Readings (15)

You may use the datalogging facility to record up to 190 A Frame results. Take readings at regular intervals, or write down the distance between measurements and the log number. To save readings keep the A Frame in ground contact and push "Shift" key, and touch "Depth" key.

The Display will show "Sav", and the log number in the top left corner of the LCD.

Reviewing PCM FF data.

Remove the PCM Magnetometer foot if it is fitted. Press Peak/Null key (8) to change to peak, and press (#) mode key (7) to select Review mode. The LCD will show "Log", then the most recent log number will be displayed at the top left corner of the LCD. The dB microvolt value of the PCM FF result and the direction of the faultfind arrows will be shown on the LCD.

Data Upload – PCM FF Data.

When the survey is completed the stored data can be uploaded to PC/laptop, but the magnetometer foot must be detached from the PCM receiver to access the stored Fault Find data. Upload procedure is the same as for the 4 Hz current gradient readings using the PCM data upload utility program, and the file name is FFData.TXT Please see software section 11, page 40 for more information.

Pipeline Current Mapper User Guide

Section 8

Avoiding sources of error to achieve consistent results.

Always use the standard techniques to ensure measurements are valid. Confirm that peak and null signals coincide. If in doubt check for field distortion by taking a depth reading and then raise the receiver a known height (say 0.5M) and confirm the depth measurement increases by the corresponding amount. As the PCM uses such a low frequency the sources of error are much reduced. However there are still certain circumstances that will create errors.

Identifying Interference

- Poor Peak and Null locate, outside 15 cm/6 inch maximum.

Errors due to locate (ELF/LF) signal distortion can result in errors in 4Hz current measurement. This is because the 4Hz current measurement process relies on depth as measured by the ELF or LF signal.

- Unreasonable depth measurement.
- Reading on LCD bargraph not stable.
- LCD displays "Err" numbers 11 or 29.

Reason for Interference

- Parallel pipes.
- Too close to transmitter. Tie-ins, T-junctions and L bends.

Measurements at Ts, bends, abrupt changes in depth etc. should be avoided, as there will always be a degree of field distortion at these points.

- Taking readings too close to large parked vehicles, moving vehicles, boots or shoes with steel toe caps or large metal structures.
- Taking readings near to PCM transmitter and anode cables or anode groundbed.

Measurements taken near the transmitter anode bed or earth stake can be misleading. This is because all the signal current passes through the earth stake or anode bed. The signal ground currents close to the transmitter are therefore significant and opposite to the pipe current.

The effect is that for the first 30 - 50 meters or so (depending on ground conditions) the measured current may increase. In fact the current on the pipe is probably at a constant level.

If it is necessary to survey this section of pipe it will be necessary to apply the transmitter at a different location and work back to this point.

Locate current

- In ELF and with a locate reading current below 15 mA the PCM readings will not be accurate.
- In LF and with a locate reading current below 2 mA the PCM reading will not be accurate.

PCM Current.

- PCM current results depend on locate current. If the PCM current has fallen below 100mA on a long survey, it is likely that the locate current is also low. It is possible to obtain results by using a portable transmitter nearby to provide a locate signal. Use a different frequency from the PCM transmitter locate frequency. Please see section 1, page 6.

Direction Arrows

- The direction arrow indicates current flow to the transmitter.
- A direction arrow will not be displayed if the transmitter is set to the ELF(4Hz + 128Hz) mode. Please see PCM transmitter section 1.
- A direction arrow will not be displayed if the PCM receiver is unsure of the current direction. However the current reading will still be accurate.

Pipeline Current Mapper User Guide

Section 8

Interpretation of PCM results.

Introduction

The principle of the PCM is that the frequency used is so low (4Hz) that the effects of induced and capacitance coupling to other lines are reduced to almost zero. Also natural decay of the signal due to these effects is also reduced to almost zero.

The losses are due completely to resistive losses i.e. coating defects or contact to other structures.

Interpreting results from a survey:-

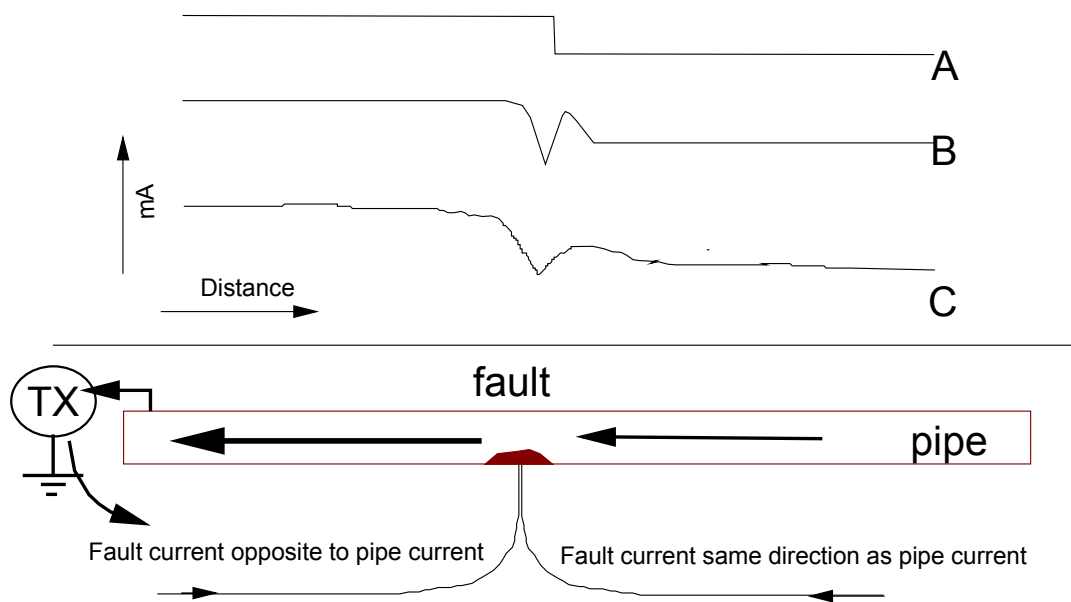

Taking a classical situation as above, graph "A" shows the ideal response which is a loss of signal current and a step response, but excludes any effects from fault currents in the ground.

In practice the results obtained require some interpretation because sometimes the magnetic field detected from the pipe may be affected by other signal paths in the ground, including around the position of coating defects.

Graph "B" shows the theoretical effects of the fault current in the ground. Note that the local fault current enters the pipe from both directions and this distorts the magnetic field around the pipeline close to the fault. A short distance from the fault the ground currents subtract from the pipe current, which is measured as current reduction. A short distance after the fault they add to the pipe current, which is measured as current increase. At some distance from the fault, current settles to a steady state.

- If this local effect is observed, it is useful for detecting defects.

Graph "C" shows what would be expected in the real situation if PCM currents were plotted over a section of pipe with a coating defect.

Depending on the fault characteristics, the effect of the magnetic field distortion will spread over a distance of perhaps 2 to 10 meters either side of the fault, and the effect will vary depending on the type and severity of the fault.

Pipeline Current Mapper User Guide

Section 8

A fault caused by the surveyed pipeline being in contact with another structure, such as another pipe or cable running across the pipeline, will show some distortion of the magnetic field directly over the contact, but is unlikely to show the rise in current after the fault.

These effects are more noticeable when the survey is performed over a short distance either side of a fault.

This highlights the need to perform surveys over a complete section before attempting a more detailed survey of suspect areas.

Pipeline Current Mapper User Guide

Section 9

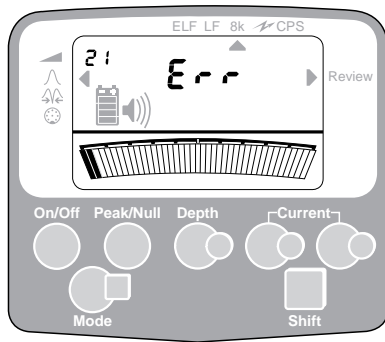

Error Codes

The PCM will display 'Err' when it is operated in unfavourable electromagnetic conditions or there is an equipment fault.

Many of the errors can be overcome by alternative signal application or measurement positions.

Error Codes are indicated by the words 'Err', with the specific code being displayed in the top left hand corner.

Some error codes will require the PCM receiver to be returned to your Radiodetection or your Distributor for examination.

Operational Errors

Error #9 - Indicates that the signal is too small or too large to measure depth/current. Check Transmitter settings.

Error #11 - Indicates a strong overhead signal.

Error #21 - Indicates that depth to target line is beyond depth measurement range.

Error #26 - PCM ERROR, Problem communicating with PCM attachment. Check attachment is properly connected and repeat operation.

Error #27 - PCM LOG ERROR, PCM attachment datalog has been corrupted. You may ignore this in order to salvage the data in the log. An upload or log erase will clear this error.

Error #28 - NOT ENOUGH MEM, software error. Turn the locator off then on to reset software.

Error #29 - AGC FAIL, locator unable to automatically set gain for depth or current measurement. Either insufficient ELF or LF signal, or there is interference. Try measurement again.

Equipment Errors

Errors #12 to 19 inclusive and 23, 24, 45 require the unit to be returned to Radiodetection for rectification.

Error #26 may require return of unit to Radiodetection.

Pipeline Current Mapper User Guide

Section 10

Changing LCD Display

Options for PCM Receiver

The PCM receiver display configuration may be changed by the user, but incorrect key presses may cause PCM to “lock”, so these instructions must be followed EXACTLY.

Options available:

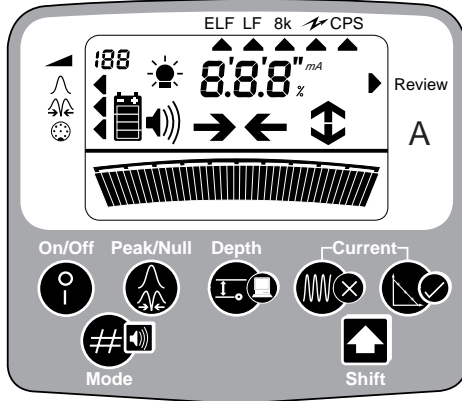

1. Language.

The language on the display can be changed between “Gb” English, “Fr” French, “Ger” German, “nL” Dutch, “ItL” Italian. Choosing different language change translations for Depth, Current, Error, Log review etc.

2. Depth Calculation.

Depth can be changed between Metric (M/cm) and Imperial (Feet and Inches).

Additionally this can be chosen at the point of downloading to PC on the Download software main control panel.

3. Current Measurement and PCM 4 Hz Current Measurement.

Current Measurement can be changed between A/mA and dBmA.

Data displayed on the LCD will be shown either in mA or dBmA depending on this selection.

Note: It is generally easier to discover pipeline faults using mA on the display, as there is a larger numerical change in the review mode using mA instead of dBmA. This selection is best chosen by user experience.

Data stored in the PCM datalogger will always be in both A/mA and dBmA, and either of these can be selected from the spreadsheet after download.

*The datastream output from the RS232 socket on PCM's with software up to 5.02 for use by an external datalogger or datalogging GPS system will include current mA or dBmA dependent on this selection. PCM's with software version 5.03 include both mA and dBmA independently of this selection. **Please see Section 13 of this manual.***

4. Power frequency filter selection.

The software contains different digital filter settings for either 50 Hz or 60 Hz power environments.

Note: The CPS frequency 100 Hz or 120 Hz and the LF and ELF frequency remain at their original factory settings.

5. 50/60 Hz Power mode activate.

Activates (on) or deactivates (off) the Power mode.

Pipeline Current Mapper User Guide

Section 10

Changing the PCM Display.

There are 2 “invisible” operating keys (?) located between the mode (# 7) key and the shift key 3, these are used to change selection, and the mode (# 7) key is used as “Enter” key.

If no change is needed press the mode (# 7) key to enter and move to the next stage. When all stages have been completed the PCM will return to its last used settings, like a normal start up.

To start the process, follow the instructions below.

Start with the PCM receiver switched off and hold down PCM (✓) key (14), push On key, and continue to hold down PCM (✓) (14) until display shows language as in 1. Above.

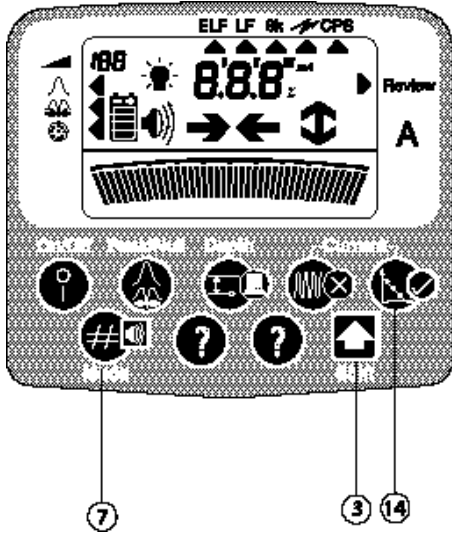

1. To change the language:
Use the 2 “invisible” (?) keys to change and (# 7) to enter.
2. Display will show a small cm for Metric or ‘ ‘ for Imperial. Use the invisible keys to change and (# 7) to enter.
3. Display will show a small mA for milliamps or dB for decibels. Use invisible keys to change and (# 7) to enter.
4. Display will show 50 or 60 for power frequency. Use invisible keys to change and (#) to enter.
5. Display will show “on” or “off”. On means that the 50/60 Hz Power mode is activated, off means that it is deactivated. Use the invisible keys to change and (# 7) to enter.

Display will now return to it's normal operation with any new settings functioning.

To alter any function, switch off the receiver and repeat the process again.

Pipeline Current Mapper User Guide

Section 11

PCM Upload Software Instructions- for software up to version 1.01

The PCM upload software supplied by Radiodetection needs to be installed onto a PC/Laptop.

If the PC forms part of a network then the IT department needs to perform the installation.

Software Installation Procedure

From the window screen

- open - File Manager/Windows Explorer
- select drive - A
- select - install.exe and press return.

A test will now be performed to verify that enough disk space is available.

- select - OK and press return.
- enter - required file destination and press return.

The software will automatically be loaded onto the PC/Laptop. When complete a new window group containing the following icons 'UPLOAD' and 'SURVEY DATA' will appear.

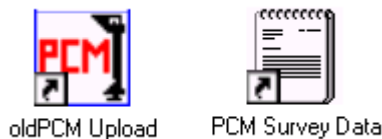

Data Upload - PCM Current data.

Fit the PCM magfoot to the PCM receiver, switch on, and select Review Mode.

Connect a standard RS232 pin-to-pin serial lead between the PCM and PC/Laptop.

Open the windows PCM work group
Select - 'Upload ' icon and press return.

The Upload screen will appear. Before Uploading make the selections for port, measurement units and Delimiter.

Select Com ports from COM1 or COM2

Select Measurement units (inches or centimetres).
Note that whichever is chosen now will appear on download data independently of the PCM receiver settings.

Select Delimiter from comma, space, colon, semicolon, Tab. Comma is normally used with Lotus 123 spreadsheet, and Tab is normally used with Microsoft Excel Spreadsheet.

Select- Upload and press return.

On the PCM receiver- press the upload (Depth) key (16).

Upon a successful completion the data is erased from the PCM and a 'no log' message is displayed on the PCM receiver LCD

The data is stored under the name MAPDATA.txt
This allows the information to be imported into a spreadsheet.

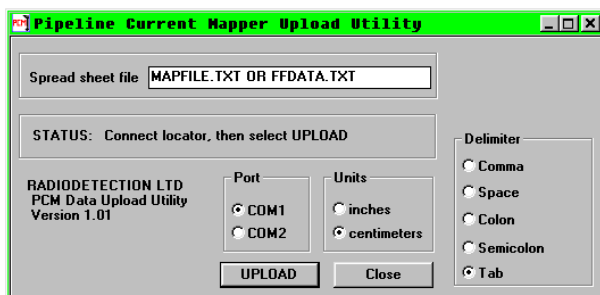

Pipeline Current Mapper User Guide

Section 11

Survey Data

This allows the operator to quickly check the data without entering the spreadsheet. To view the survey data, click on the PCM survey data icon.

Spreadsheet

After importing the information into a spreadsheet it is essential to enter the measurement distances and save the spreadsheet under a new name.

Data Upload PCM FF Data

Do not connect the PCM magnetometer foot. Switch on the PCM receiver and select Review mode. The PCM LCD will display Review and the A Frame indicator flags.

Connect a standard RS232 pin-to-pin serial lead between the PCM and PC/Laptop, and Upload as PCM Survey data.

The file will be named FFDATA.txt.

PCM faultfind data

The PCM Faultfind Data can be viewed by opening the PCM FF Datalog icon.

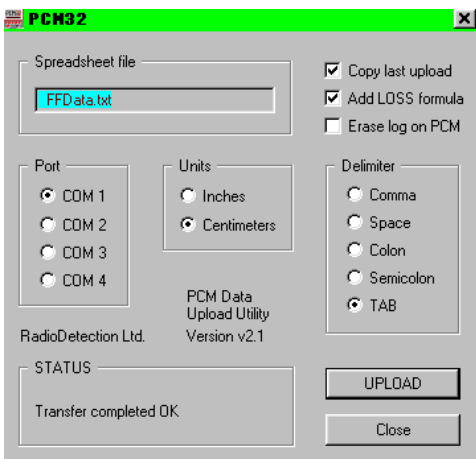

The screenshot shows a Notepad window titled 'FFData.txt - Notepad'. The text inside is as follows:

```
PCM FF Receiver Datalog Upload File 02-01'01 16:17:40
Log # Distance (dB) Fault Signal Direction
1 71 Forward Forward
2 71 Forward Forward
3 71 Forward Forward
4 71 Forward Forward
5 71 Forward Forward
6 71 Forward Forward
7 62 Forward Forward
8 58 Forward Forward
9 58 Forward Forward
10 62 Forward Forward
11 61 Forward Forward
12 61 Forward Forward
13 61 Forward Forward
14 65 Forward Forward
15 65 Forward Forward
16 75 Forward Forward
17 76 Forward Forward
18 100 Forward Forward
19 74 Forward Forward
20 68 Reverse Reverse
21 68 Reverse Reverse
22 80 Reverse Reverse
23 73 Reverse Reverse
24 72 Reverse Reverse
25 67 Reverse Reverse
```

Pipeline Current Mapper User Guide

Section 11

Software Installation Procedure – using PCM Data Utility Upload version V.2.1 (Pcm32)

From the window screen

- Open - Windows Explorer
- Select drive - A
- Select - install.exe and press return.

A test will now be performed to verify that enough disk space is available.

Select - OK and press return.

Enter - required file destination and press return.



Pcm32



Pcm32 Datalog



Pcm32 FF Datalog

The software will automatically be loaded onto the PC/Laptop. When complete a new window group containing the following icons 'PCM32 UPLOAD' and 'PCM32 Datalog' and 'PCM32 FF Datalog' will appear.

Viewing PCM Survey Data

The download data can be viewed by opening PCM 32 Datalog icon.

Viewing PCM faultfind Data

The PCM Faultfind Data can be viewed by opening the PCM 32 FF Datalog icon.

Data Upload Version 2.1

– Uploading PCM FF data.

Do not connect the PCM magnetometer foot. Switch on the PCM receiver and select Review mode. The PCM LCD will display Review and the A Frame indicator flags.

DATAREPORT Software.

In addition to the PCM data upload utility program, there is the alternative DATAREPORT software for storing and archiving PCM data.

The Dongle for operating the software is available from Radiodetection (part number 52/PM2093PC) and the latest software can be downloaded from Intermedia's website. <http://www.imedia.fr>.

Please contact Radiodetection for more information

Pipeline Current Mapper User Guide

Section 11

PCM Upload Version 2.1

- Uploading PCM Current data.

Fit the PCM magfoot to the PCM receiver, switch on, and select Review Mode.
Connect the standard RS232 pip-to-pin serial lead between the PCM and PC/Laptop.



To Start PCM32 Upload, click on the Icon.

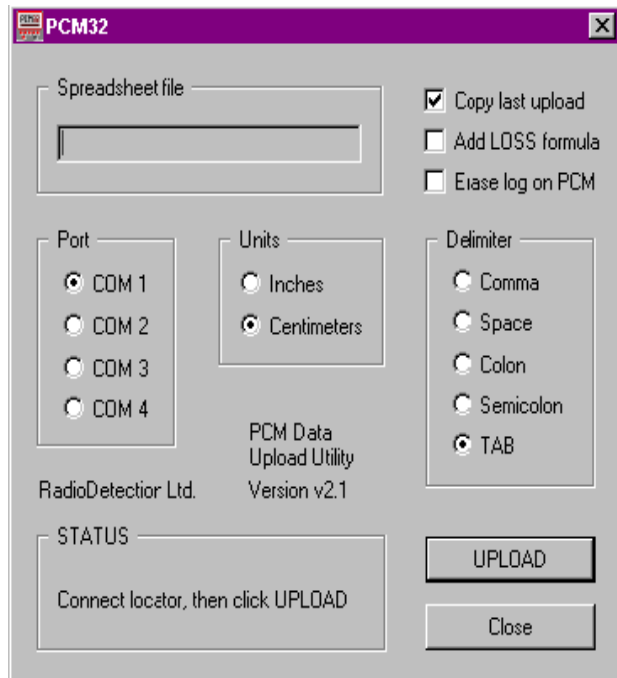

Once Started the PCM32 main control panel will be displayed. This panel allows full control of PCM32 setup and options.
Set up the software selection when using it for the first time. Set up options will be saved for future use.

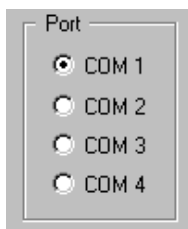

Select the required Com port to be used for connecting the PCM receiver.

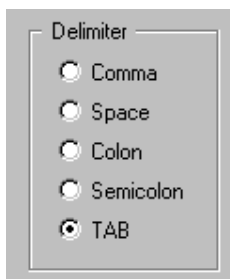

The PCM receiver records its data in a text delimited file. During upload you can select the type of delimiter used by the spreadsheet application that will display the data. For example Lotus123 uses 'Comma' and Microsoft Excel prefers 'Space or Tab'.

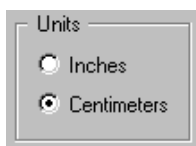

During data upload the Depth measurement units can be set to either Metric or Imperial units.

Pipeline Current Mapper User Guide

Section 11

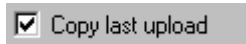
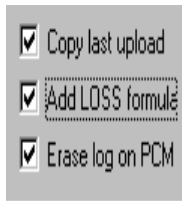

With 'Copy Last Upload' checked the uploaded data will be automatically copied to the PC's Clipboard for easy pasting into a spreadsheet. *Note this **ONLY** works with MS Excel.*



With 'Add Loss formula' checked an extra column of data will be included during upload. PCM32 will automatically calculate the dB loss per kilometer, when the distance between PCM readings is entered in the Excel spreadsheet.



With 'Erase log on PCM' checked the PCM boot **will** be erased after a successful upload, with the check removed the data will be copied from the boot to the PC and remain on the boot for future removal.

To delete the datalogger readings stored in the PCM foot, select Review mode and use the Shift + Current keys on the PCM receiver.

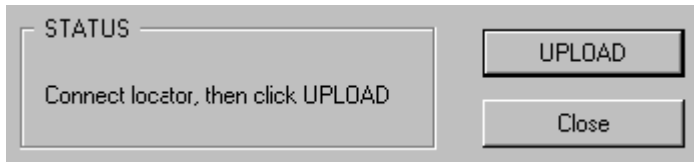

Once PCM32 is setup with the required options you are ready to upload the data from your PCM receiver. Using a standard RS232C lead connect the selected Comm port of your computer to the RS232 socket on the back of your PCM receiver. Switch on the PCM and using the mode key select the 'Review' mode.



Press the Upload button on PCM32, the status window will briefly show Opening port then Waiting for PCM (see pics)



Once PCM32 is waiting for the PCM, press the Depth key (16) on the PCM receiver, this will initiate the Upload, a brief message will indicate that data is being uploaded. The data will be transferred to the PC Clipboard

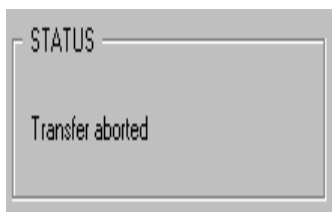

If for some reason the upload needs to be stopped, press the abort button. For example, poor comms between PCM32 and the PCM receiver, or an incorrect setup.

Once the Upload is complete PCM32 can be closed down and the data is ready for display.

Viewing Survey Data

Uploaded data can be viewed by opening the PCM32 Datalog icon, or the data can be opened in the Spreadsheet.

Pipeline Current Mapper User Guide

Section 12

Preparing the PCM graph using Microsoft Excel

Three methods to present the PCM results are shown in the following pages of this section.

Pages 45-49 explain basic 2 axis graph of Distance against Current (X) & (Y).

Pages 50-58 explain method to include 2 (Y) axes, using Distance against Current dBmA and Depth.

Pages 59-67 explain Distance against Current dBmA and Rate of Current loss MilleBels per Metre (mB/M)

Microsoft Excel - SimulationGasPipelinedata.xls						
File Edit View Insert Format Tools Data Window Help						
Arial 10 B I U % , .00 +.00						
B7 = 0						
	A	B	C	D	E	F
1	PCM Receiver Datalog Upload File - September 7 '99 17:28:16					
2						
3	Log	Distance	4Hz	4Hz	Direction	Depth
4	Number		(mA)	(dBmA)		(cm)
5						
6						
7	1	0	293.3	49.35	Undefined	66
8	2	25	273.5	48.74	Reverse	64
9	3	50	265	48.46	Reverse	63
10	4	75	263.5	48.42	Reverse	62
11	5	100	260.1	48.3	Reverse	63
12	6	125	257.4	48.21	Reverse	60
13	7	150	257.3	48.21	Reverse	62
14	8	175	254.6	48.12	Reverse	61
15	9	200	253.8	48.09	Reverse	61
16	10	225	253.3	48.07	Reverse	62
17	11	250	249.2	47.93	Reverse	58
18	12	275	248.7	47.91	Reverse	60
19	13	300	247.7	47.88	Reverse	59
20	14	325	246.2	47.83	Reverse	58
21	15	350	246.2	47.83	Reverse	58
22	16	375	245.6	47.8	Reverse	59
23	17	400	245.3	47.79	Reverse	58
24	18	425	239.4	47.58	Reverse	57
25	19	450	238	47.53	Reverse	54
26	20	475	230.1	47.24	Reverse	128
27	21	500	229.6	47.22	Reverse	58
28	22	525	223.6	46.99	Reverse	117
29	23	550	204	46.19	Reverse	49
30	24	575	188.4	45.5	Reverse	111
31	25	600	182.9	45.24	Reverse	87

Spreadsheet – PCM current data

Open MS Excel, File, new.

Select Edit from toolbar, and Paste from pull down menu (or use Ctrl +V)

This will open the clipboard contents in MS Excel and your data will appear in columns A-F. Column G will also be used if “Add LOSS Formula “box was ticked.

Save and name your file now if you did not previously

1. Enter the distance information from your survey notes in column B. If you took measurements at regular distances, use the summation formula.

Pipeline Current Mapper User Guide

Section 12

The screenshot shows an Excel spreadsheet with the following data:

Log Number	Distance	4Hz (mA)	4Hz (dBmA)	Direction	Depth (cm)
1	0	293.3	49.35	Undefined	66
2	25	273.5	48.74	Reverse	64
3	50	265	48.46	Reverse	63
4	75	263.5	48.42	Reverse	62
5	100	260.1	48.3	Reverse	63
6	125	257.4	48.21	Reverse	60
7	150	257.3	48.21	Reverse	62
8	175	254.6	48.12	Reverse	61
9	200	253.8	48.09	Reverse	61
10	225	253.3	48.07	Reverse	62
11	250	249.2	47.93	Reverse	58
12	275	248.7	47.91	Reverse	60
13	300	247.7	47.88	Reverse	59
14	325	246.2	47.83	Reverse	58
15	350	246.2	47.83	Reverse	58
16	375	245.6	47.8	Reverse	59
17	400	245.3	47.79	Reverse	58
18	425	239.4	47.58	Reverse	57
19	450	238	47.53	Reverse	54
20	475	230.1	47.24	Reverse	128
21	500	229.6	47.22	Reverse	58
22	525	223.6	46.99	Reverse	117
23	550	204	46.19	Reverse	49
24	575	188.4	45.5	Reverse	111
25	600	182.9	45.24	Reverse	87
26	624	177.2	44.97	Reverse	32
27	650	145.7	43.27	Reverse	97
28	675	144.2	43.18	Reverse	60

The Chart Wizard dialog box is open, showing the 'Standard Types' tab. The 'XY (Scatter)' chart type is selected. The 'Chart sub-type' section shows a preview of a scatter plot with smoothed lines. The description below the preview reads: 'Scatter with data points connected by smoothed Lines.' A button labeled 'Press and hold to view sample' is visible.

2. Highlight Distance column B
3. Hold down CTRL and highlight 4 Hz dBmA column D.
4. Click on Chart Wizard from the Toolbar
5. From chart type select "XY Scatter".
6. Choose a graph form.

This is a close-up view of the Chart Wizard dialog box. The 'XY (Scatter)' chart type is highlighted in the 'Chart type' list. The 'Sample' section displays a line graph with data points connected by smoothed lines. The y-axis ranges from 0 to 60, and the x-axis ranges from 0 to 2000. The description below the sample graph reads: 'Scatter with data points connected by smoothed Lines.' A button labeled 'Press and hold to view sample' is visible.

7. Press and hold bar to view sample and click on "Next"

Pipeline Current Mapper User Guide

Section 12

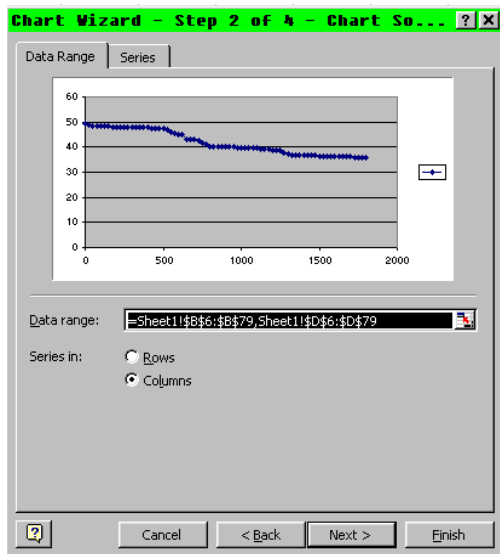

8. Move to step 2 on Chart Wizard. This shows a graph picture and the data ranges; different data ranges can be selected at this stage if a small part of the total data is needed.

9. Move to step 3 of Chart Wizard and insert Chart Title, Values of X Axis and Title (Distance Metres) and Y Axis (Current dBmA).

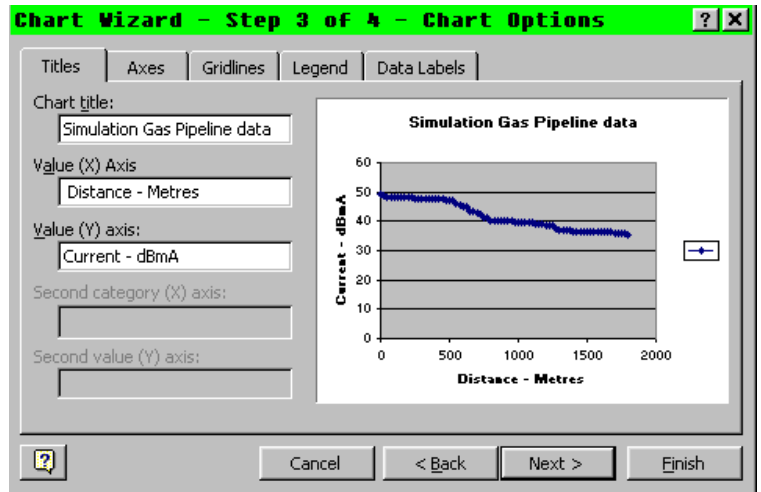

10. Choose if the data chart and graph are to be placed on the same page or the graph is to be placed on a new sheet. (New sheet is preferable).
11. Click on "Finish" and the graph will appear.

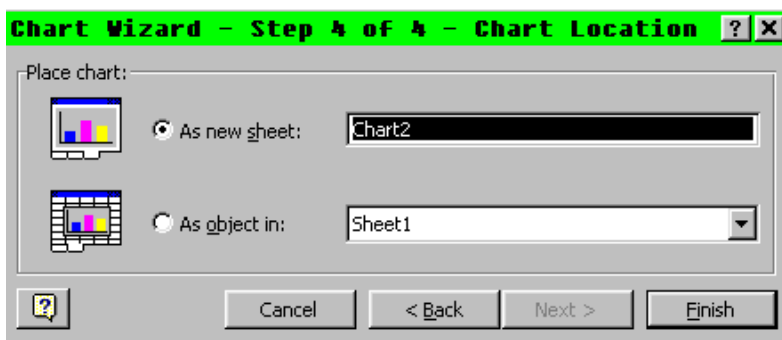

Pipeline Current Mapper User Guide

Section 12

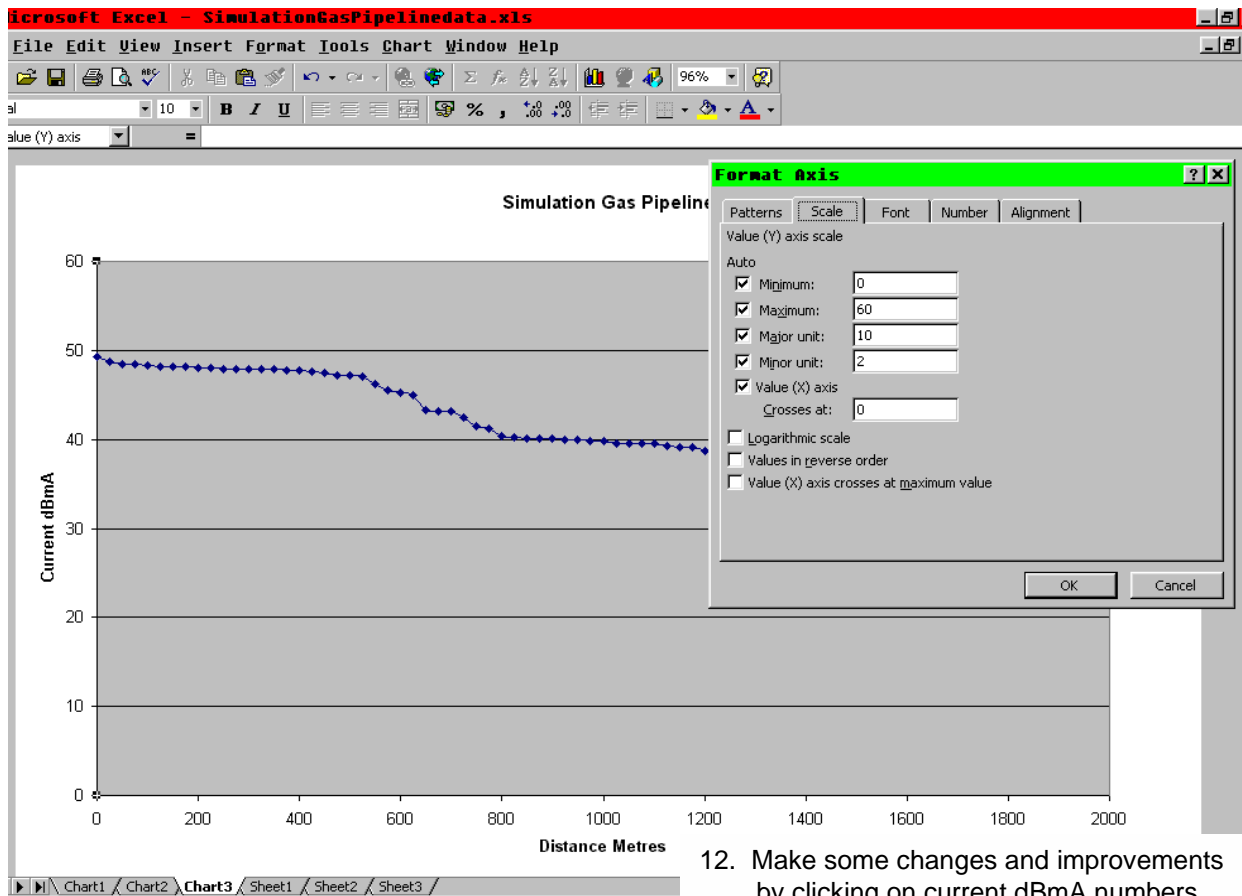

- Make some changes and improvements by clicking on current dBmA numbers and changing the min and max values. Format axis menu appears. Click on each max and min and use a appropriate value to make graph of current loss easier to understand.

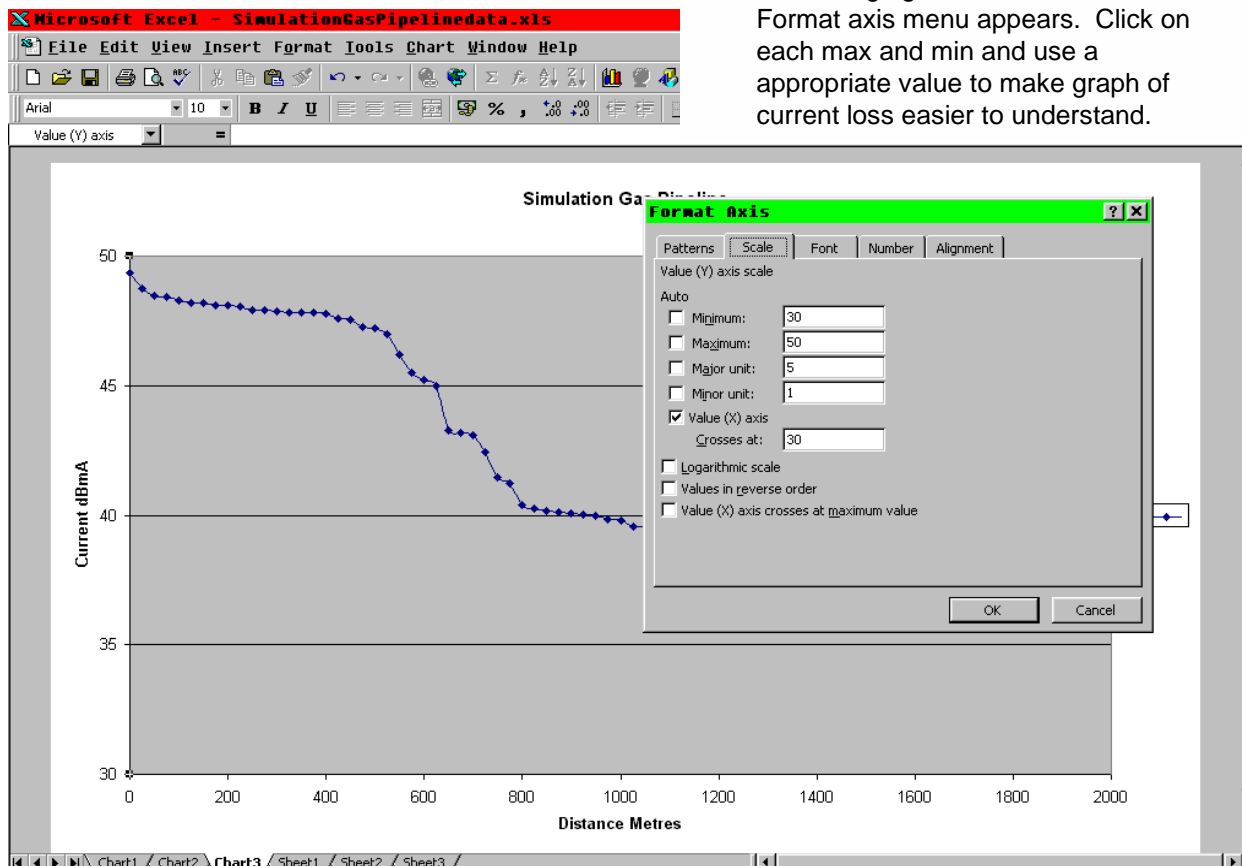

Pipeline Current Mapper User Guide

Section 12

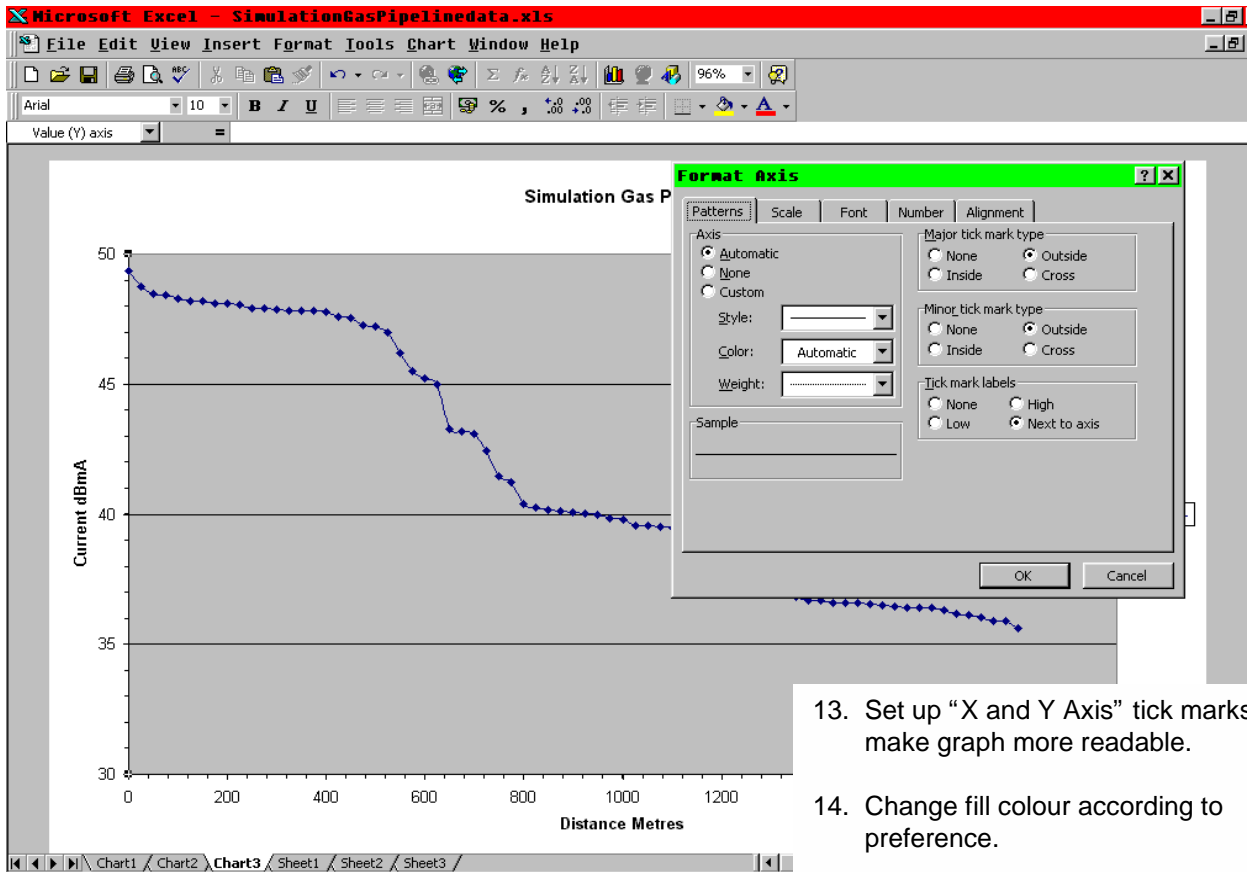

13. Set up "X and Y Axis" tick marks to make graph more readable.

14. Change fill colour according to preference.

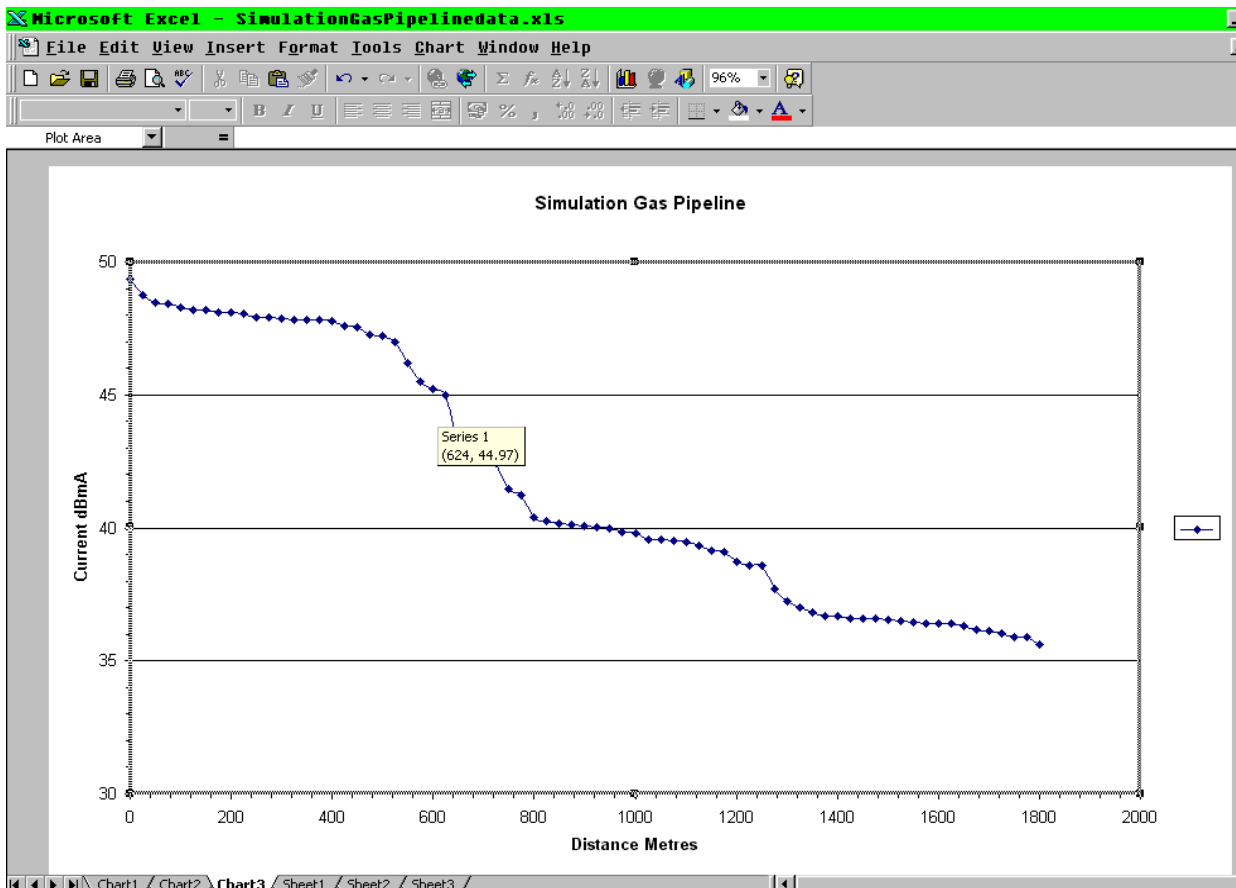

Pipeline Current Mapper User Guide

Section 12

Using MS Excel to prepare a graph which used 2 (Y) Axes, such as Distance against Current in dBmA and Depth, or Distance against dBmA and Current Loss Rate in milliBels/metre.

	A	B	C	D	E	F	G	H	I	J	
1	PCM Receiver Datalog Upload File - September 7 '99 17:28:16										
2											
3	Log	Distance	4Hz	4Hz	Direction	Depth	Loss				
4	Number		(mA)	(dBmA)		(cm)	(mB/metre)				
5											
6											
7	1	0	293.3	49.35	Undefined	66	0				
8	2	25	273.5	48.74	Reverse	64	24.4				
9	3	50	265	48.46	Reverse	63	11.2				
10	4	75	263.5	48.42	Reverse	62	1.6				
11	5	100	260.1	48.3	Reverse	63	4.8				
12	6	125	257.4	48.21	Reverse	60	3.6				
13	7	150	257.3	48.21	Reverse	62	0				
14	8	175	254.6	48.12	Reverse	61	3.6				
15	9	200	253.8	48.09	Reverse	61	1.2				
16	10	225	253.3	48.07	Reverse	62	0.8				
17	11	250	249.2	47.93	Reverse	58	5.6				
18	12	275	248.7	47.91	Reverse	60	0.8				
19	13	300	247.7	47.88	Reverse	59	1.2				
20	14	325	246.2	47.83	Reverse	58	2				
21	15	350	246.2	47.83	Reverse	58	0				
22	16	375	245.6	47.8	Reverse	59	1.2				
23	17	400	245.3	47.79	Reverse	58	0.4				
24	18	425	239.4	47.58	Reverse	57	8.4				
25	19	450	238	47.53	Reverse	54	2				
26	20	475	230.1	47.24	Reverse	128	11.6				
27	21	500	229.6	47.22	Reverse	58	0.8				
28	22	525	223.6	46.99	Reverse	117	9.2				
29	23	550	204	46.19	Reverse	49	32				
30	24	575	188.4	45.5	Reverse	111	27.6				
31	25	600	182.9	45.24	Reverse	87	10.4				

1. Do NOT highlight any columns – this is done at a later stage – instead click on any worksheet box outside the data columns.
2. Click on Chart Wizard

Pipeline Current Mapper User Guide

Section 12

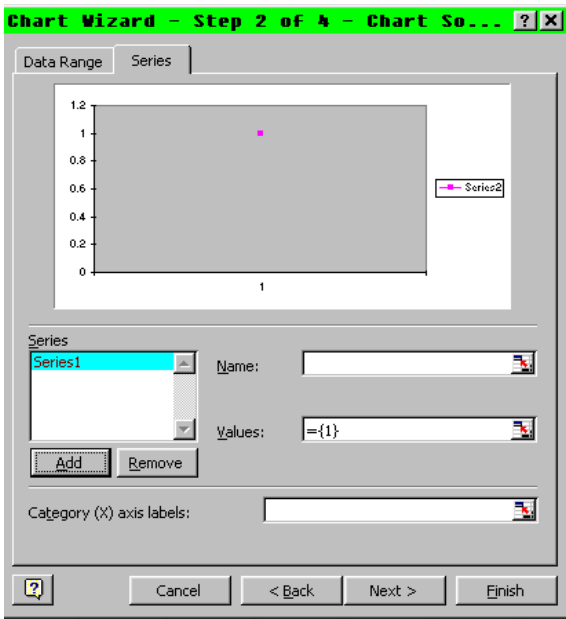

6. Click on “Add” – Series box will display “Series 1” and Blank Graph will appear.
7. “Series 1” will be replaced when you click in the Name: box and type in “Current dBmA”.
8. In the “Category (X) axis labels”, Click on the small red arrow: the box will change into a long rectangular box Chart Wizard – step 2 of 4 – Chart so...”

	A	B	C	D	E	F	G	H	I	J	K	L	M	N	
1	PCM Receiver Datalog Upload File - September 7 '99 17:28:16														
3	Log	Distance	4Hz	4Hz	Direction	Depth	Loss								
4	Number		(mA)	(dBmA)		(cm)	(mB/metre)								
5															
7	1	0	293.3	49.35	Undefined	66	0								
8	2	25	273.5	48.74	Reverse	64	24.4								
9	3	50	265	48.46	Reverse	63	11.2								
10	4	75	263.5	48.42	Reverse	62	1.6								
11	5	100													
12	6	125													
13	7	150													
14	8	175													
15	9	200													
16	10	225													
17	11	250													
18	12	275	248.7	47.91	Reverse	60	0.8								
19	13	300	247.7	47.98	Reverse	59	1.2								

9. On the worksheet, highlight/click and drag Distance column B – This data will appear in this box.

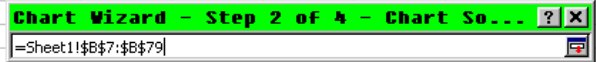

	A	B	C	D	E	F	G	H	I	J	K	L	M	N
1	PCM Receiver Datalog Upload File - September 7 '99 17:28:16													
3	Log	Distance	4Hz	4Hz	Direction	Depth	Loss							
4	Number		(mA)	(dBmA)		(cm)	(mB/metre)							
5														
7	1	0	293.3	49.35	Undefined	66	0							
8	2	25	273.5	48.74	Reverse	64	24.4							
9	3	50	265	48.46	Reverse	63	11.2							
10	4	75												
11	5	100												
12	6	125												
13	7	150												
14	8	175												
15	9	200												
16	10	225												
17	11	250												
18	12	275	248.7	47.91	Reverse	60	0.8							
19	13	300	247.7	47.98	Reverse	59	1.2							
20	14	325												
21	15	350												
22	16	375												
23	17	400	240.3	47.73	Reverse	50	0.4							
24	18	425	239.4	47.58	Reverse	57	8.4							
25	19	450	238	47.53	Reverse	54	2							
26	20	475	230.1	47.24	Reverse	128	11.6							
27	21	500	229.6	47.22	Reverse	58	0.8							
28	22	525	223.6	46.99	Reverse	117	9.2							
29	23	550	204	46.19	Reverse	49	32							
30	24	575	188.4	45.5	Reverse	111	27.6							

10. Click on the small red icon in this box, and the data will reappear in the “category (X) axis labels”, and the graph will have a dot on it.

11. Click on the small red arrow icon in “Values” box. This shows = {1}

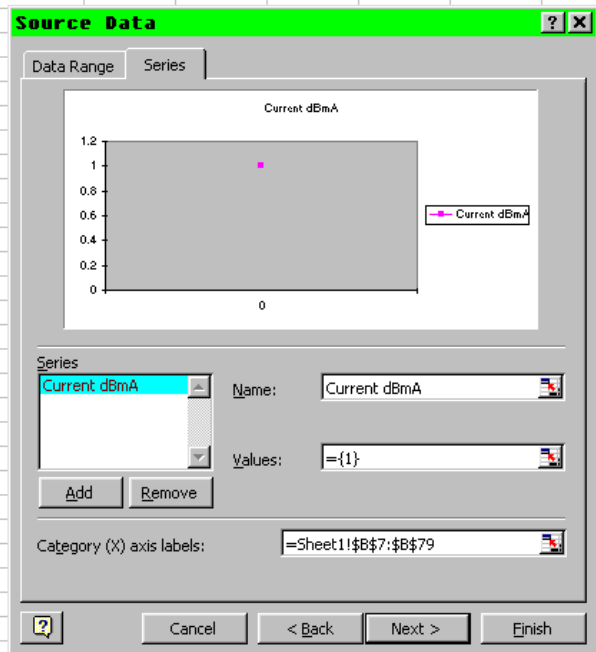

Pipeline Current Mapper User Guide

Section 12

5									
6									
7	1	0	293.3	49.35	Undefined	66	0		
8	2	25	273.5	48.74	Reverse	64	24.4		



12. The long rectangular box shows “Source Data – Values”.

5									
6									
7	1	0	293.3	49.35	Undefined	66	0		
8	2	25	273.5	48.74	Reverse	64	24.4		
9	3	50	265	48.46	Reverse	63	11.2		
10	4	75	263.5	48.42	Reverse	62	1.6		
11	5	100	260.1	48.3	Reverse	63	4.8		
12	6	125	257.4	48.21	Reverse	60	3.6		

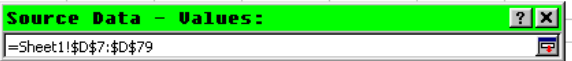

13. Highlight/Click and drag the dBmA Current column D. These values will appear in the box. Click on the small red icon.

A	B	C	D	E	F	G	H	I	J	K	L	M	N	
1	PCM Receiver Datalog Upload File - September 7 '99 17:28:16													
2														
3	Log	Distance	4Hz	4Hz	Direction	Depth	Loss							
4	Number		(mA)	(dBmA)		(cm)	(mB/metre)							
5														
6														
7	1	0	293.3	49.35	Undefined	66	0							
8	2	25	273.5	48.74	Reverse	64	24.4							
9	3	50	265	48.46	Reverse	63	11.2							
10	4	75	263.5	48.42	Reverse	62	1.6							
11	5	100	260.1	48.3	Reverse	63	4.8							
12	6	125	257.4	48.21	Reverse	60	3.6							
13	7	150	257.3	48.21	Reverse	62	0							
14	8	175	254.6	48.12	Reverse	61	3.6							
15	9	200	253.8	48.00	Reverse	61	1.2							
16	10	225	249.2	47.80	Reverse	50	0.8							
17	11	250	246.2	47.83	Reverse	58	0							
18	12	275	245.6	47.8	Reverse	59	1.2							
19	13	300	245.3	47.79	Reverse	58	0.4							
20	14	325	239.4	47.58	Reverse	57	8.4							
21	15	350	238	47.53	Reverse	54	2							
22	16	375	230.1	47.24	Reverse	128	11.6							
23	17	400	229.6	47.22	Reverse	58	0.8							
24	18	425	223.6	46.99	Reverse	117	9.2							
25	19	450	204	46.19	Reverse	49	32							
26	20	475	188.4	45.5	Reverse	111	27.6							

14. The graph now shows Distance on (X) and dBmA on (Y) axis.

A	B	C	D	E	F	G	H	I	J	K	L	M	N	
1	PCM Receiver Datalog Upload File - September 7 '99 17:28:16													
2														
3	Log	Distance	4Hz	4Hz	Direction	Depth	Loss							
4	Number		(mA)	(dBmA)		(cm)	(mB/metre)							
5														
6														
7	1	0	293.3	49.35	Undefined	66	0							
8	2	25	273.5	48.74	Reverse	64	24.4							
9	3	50	265	48.46	Reverse	63	11.2							
10	4	75	263.5	48.42	Reverse	62	1.6							
11	5	100	260.1	48.3	Reverse	63	4.8							
12	6	125	257.4	48.21	Reverse	60	3.6							
13	7	150	257.3	48.21	Reverse	62	0							
14	8	175	254.6	48.12	Reverse	61	3.6							
15	9	200	253.8	48.00	Reverse	61	1.2							
16	10	225	249.2	47.80	Reverse	50	0.8							
17	11	250	246.2	47.83	Reverse	58	0							
18	12	275	245.6	47.8	Reverse	59	1.2							
19	13	300	245.3	47.79	Reverse	58	0.4							
20	14	325	239.4	47.58	Reverse	57	8.4							
21	15	350	238	47.53	Reverse	54	2							
22	16	375	230.1	47.24	Reverse	128	11.6							
23	17	400	229.6	47.22	Reverse	58	0.8							
24	18	425	223.6	46.99	Reverse	117	9.2							
25	19	450	204	46.19	Reverse	49	32							
26	20	475	188.4	45.5	Reverse	111	27.6							

15. Click on “Add” – Series box now shows “Series 2”. Values box shows “={1}”. Type “Depth CM” in the Name Box.

16. Click on the small red icon in the Values box.

Pipeline Current Mapper User Guide

Section 12

Type these in now.

The Title will appear at the top of the graph example.

In 'Category (X) Axis' type in "Distance Metres".

In 'Value (Y) Axis' type in "Current dBmA".

In 'Second Value (Y) Axis' type in "Depth cm".

These will appear on the graph example.

Click on "Next".

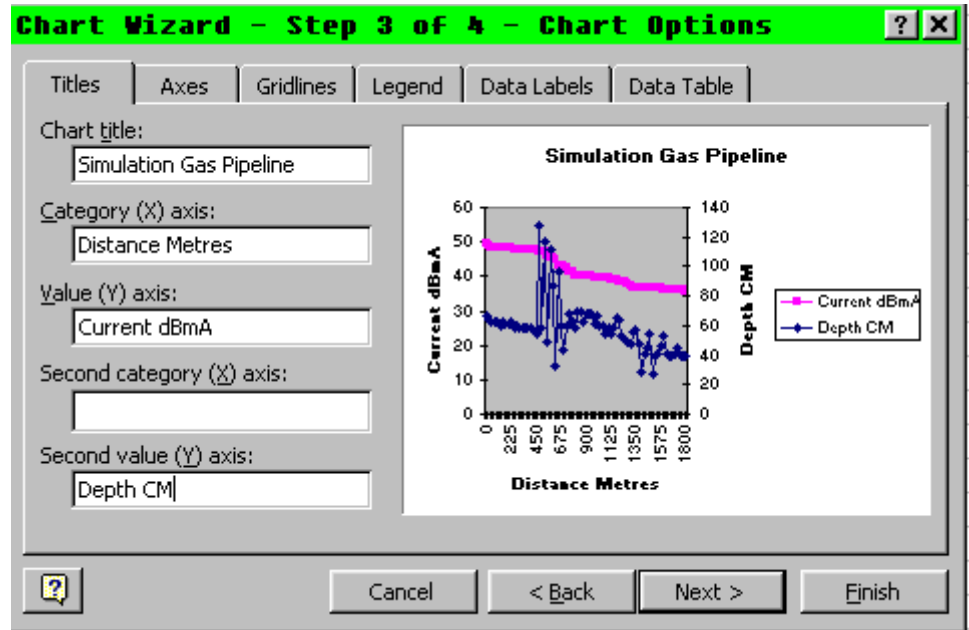

21. Chart Wizard- Step 4 of 4

The chart can be placed as a new Sheet (which is preferable), or as an object in the worksheet.

Click on the 'As new sheet' option button. Then click on Finish-the graph will appear.

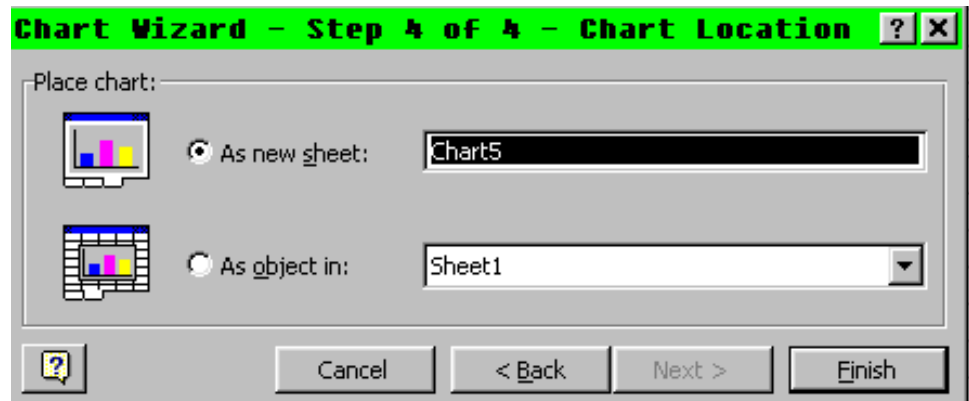

Pipeline Current Mapper User Guide

Section 12

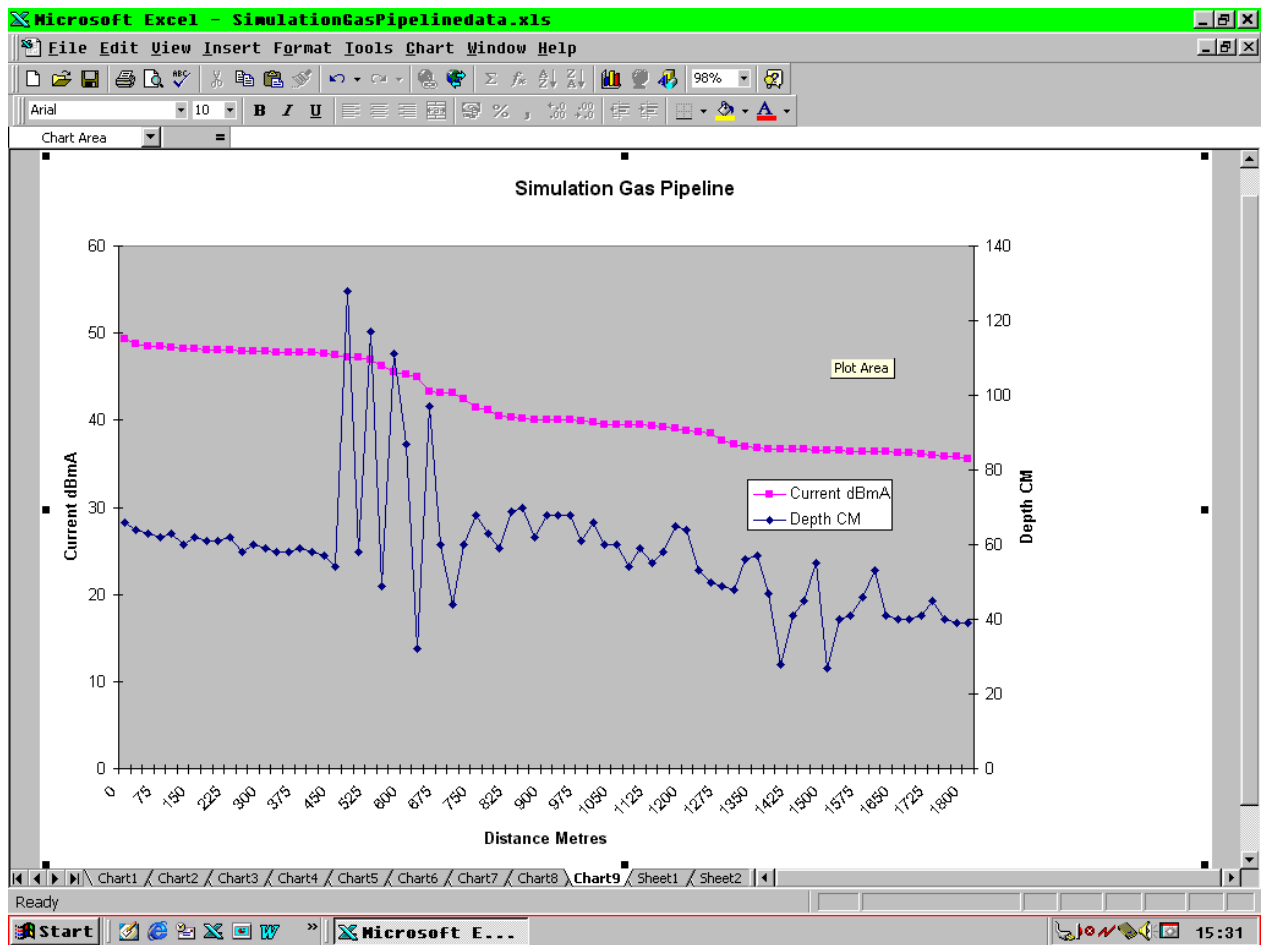

22. The next stage is to improve the appearance of the graph, and make it easier to interpret. The dBmA current does not need full scale from zero to maximum, at present the depth also starts at the same zero axis, with the greatest depth at the top of the chart. All of these can be changed.

Pipeline Current Mapper User Guide

Section 12

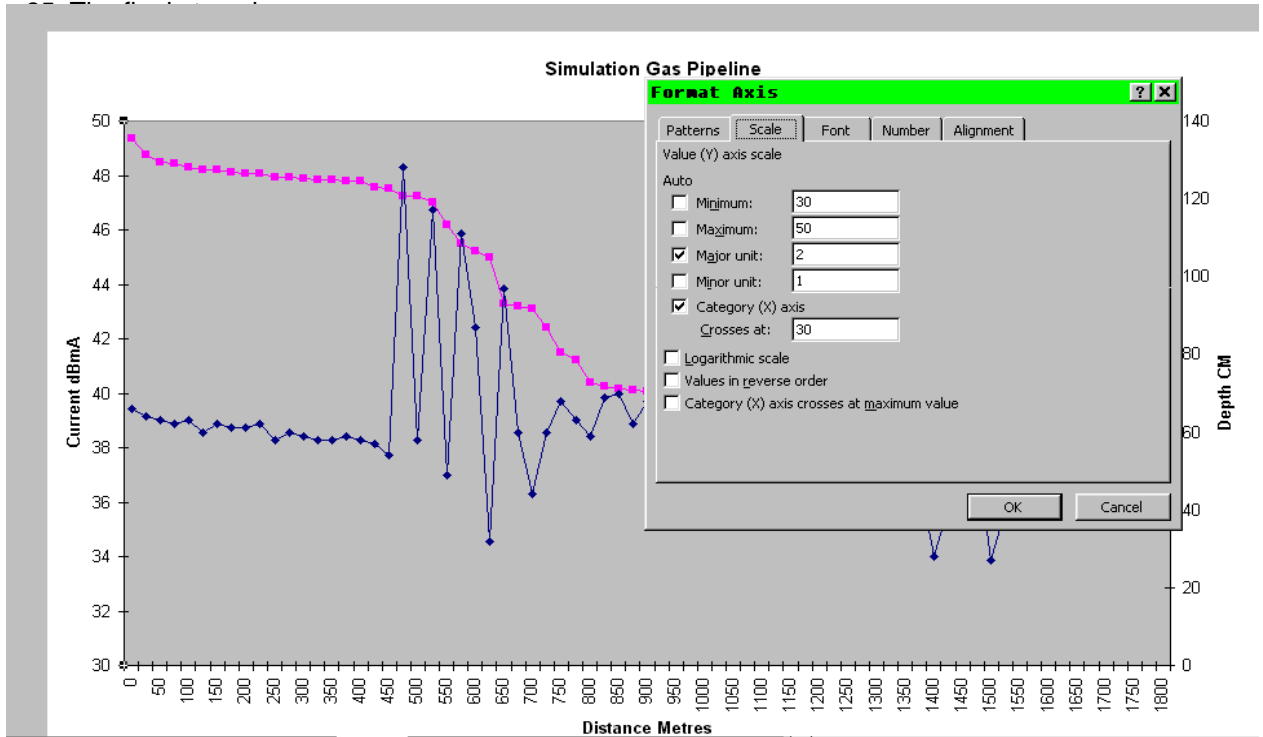

23. Double Click on the numbers beside the current dBmA (Value/Y1) axis. This shows the 'Format Axis' box. From the menu tabs, click on 'Scale'. Change the maximum and minimum values and the major and minor units – this will allow the curve/slope of the graph of the current loss to be steeper and makes the faulty sections easier to observe. Click on 'Ok' when finished.

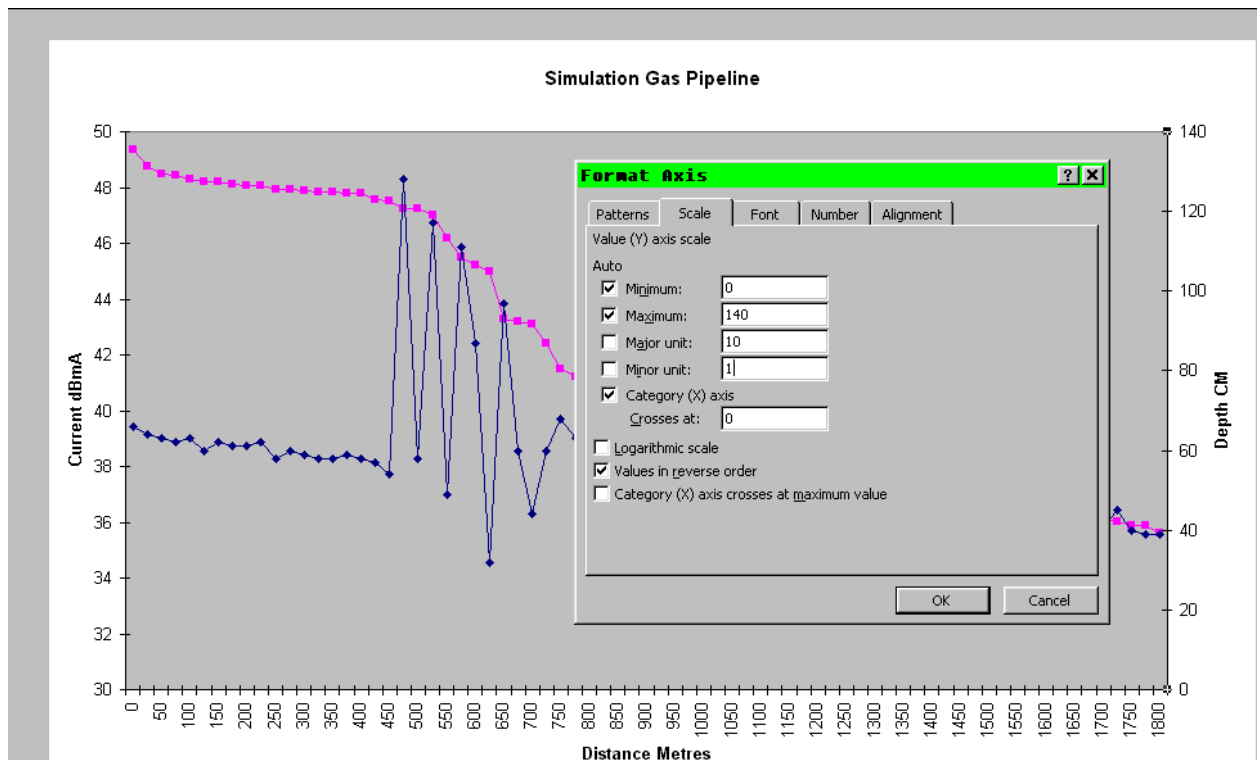

24. Double click on the numbers beside the Depth (Secondary Value/Y2) axis. Change the maximum, Minimum and major and minor unit values as necessary. To set the zero depth at the top of the graph and greatest depth at the lowest part of the graph (to give a representation of the pipeline's depth position), click in the 'Values in reverse order' box.

Pipeline Current Mapper User Guide

Section 12

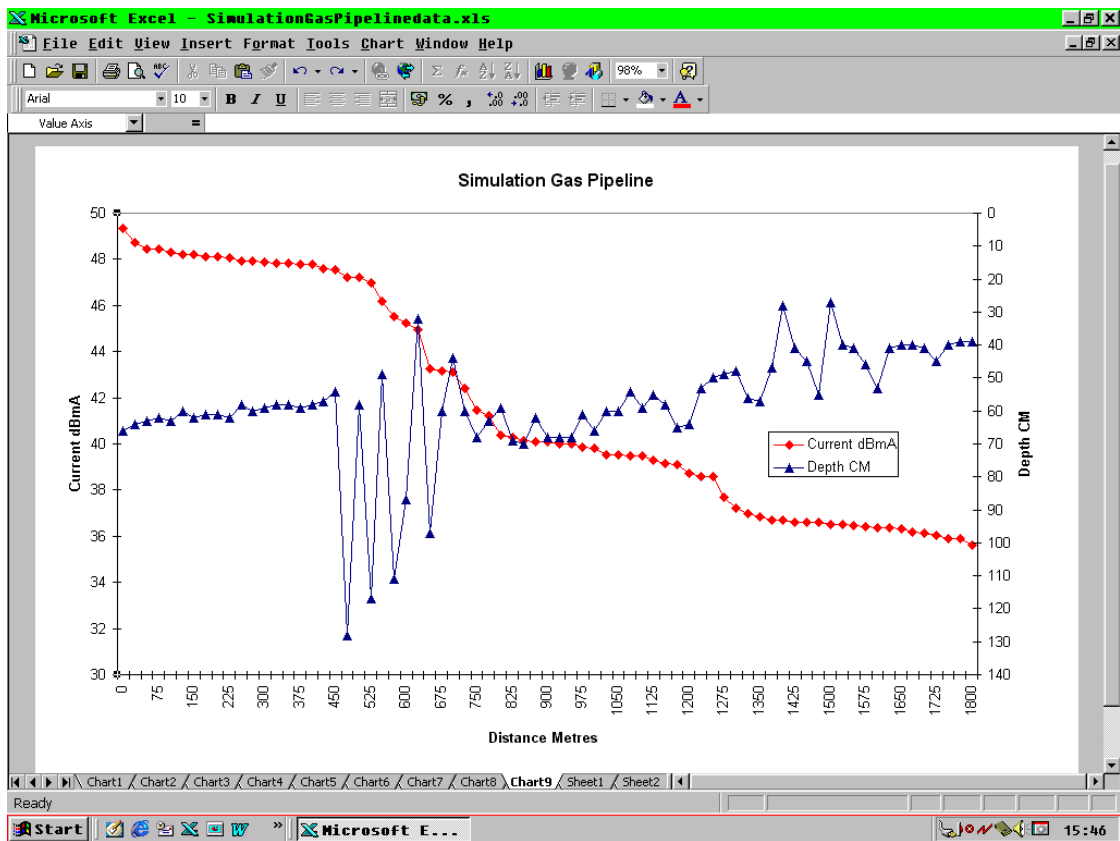

25. The final stage is to change the colours and fill colours, as in the previous instructions.

Pipeline Current Mapper User Guide

Section 12

Using Ms Excel to prepare a graph which uses 2 (Y) Axes, such as Distance against Current in dBmA and Depth, or Distance against dBmA and Current Loss Rate in milliBels/metre.

The screenshot shows the Microsoft Excel interface with the following data in the spreadsheet:

Log Number	Distance	4Hz (mA)	4Hz (dBmA)	Direction	Depth (cm)	Loss (mB/metre)
1	0	293.3	49.35	Undefined	66	0
2	25	273.5	48.74	Reverse	64	24.4
3	50	265	48.46	Reverse	63	11.2
4	75	263.5	48.42	Reverse	62	1.6
5	100	260.1	48.3	Reverse	63	4.8
6	125	257.4	48.21	Reverse	60	3.6
7	150	257.3	48.21	Reverse	62	0
8	175	254.6	48.12	Reverse	61	3.6
9	200	253.8	48.09	Reverse	61	1.2
10	225	253.3	48.07	Reverse	62	0.8
11	250	249.2	47.93	Reverse	58	5.6
12	275	248.7	47.91	Reverse	60	0.8
13	300	247.7	47.88	Reverse	59	1.2
14	325	246.2	47.83	Reverse	58	2
15	350	246.2	47.83	Reverse	58	0
16	375	245.6	47.8	Reverse	59	1.2
17	400	245.3	47.79	Reverse	58	0.4
18	425	239.4	47.58	Reverse	57	8.4
19	450	238	47.53	Reverse	54	2
20	475	230.1	47.24	Reverse	128	11.6
21	500	229.6	47.22	Reverse	58	0.8
22	525	223.6	46.99	Reverse	117	9.2
23	550	204	46.19	Reverse	49	32
24	575	188.4	45.5	Reverse	111	27.6
25	600	182.9	45.24	Reverse	87	10.4

1. Do NOT highlight any columns – this is done at a later stage – instead click on any worksheet box outside the data columns.
2. Click on Chart Wizard

Note: To calculate the loss in milliBels/meter use the formula shown in the formula bar (insert a new column if necessary or use the next blank column). Type in zero (0) in the first line cell. Highlight the second line cell and type in the formula in the formula bar. Click on the green tick next to the formula bar Highlight the column and click and drag to the last line. Click 'edit' on the toolbar. Click 'Fill' from the pull down menu. Click on the down arrow from the next menu.

Pipeline Current Mapper User Guide Section 12

F	G	H	I	J	K	L	M	N
17:28:16								
Depth (cm)	Loss (mB/metre)							
66	0							
64	24.4							
63	11.2							
62	1.6							
63	4.8							
60	3.6							
62	0							
61	3.6							
61	1.2							
62	0.8							
58	5.6							
60	0.8							
59	1.2							
58	2							
58	0							
59	1.2							
58	0.4							
57	8.4							
54	2							
128	11.6							
58	0.8							
117	9.2							
49	32							
111	27.6							



3. Click on Custom Types from the menu tab, scroll down the chart types and click on “line-column on 2 Axes” for dBmA and Current Loss Rate. Click on ‘Next’

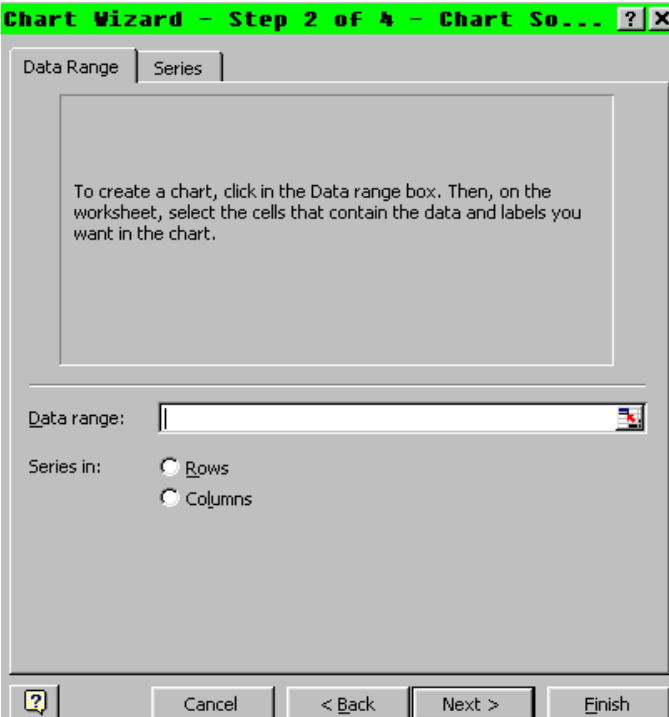

4. This shows Chart Wizard steps 2 of 4. Do not enter anything in the Data range box.
5. Click on “Series” in Menu Tabs.

Pipeline Current Mapper User Guide

Section 12

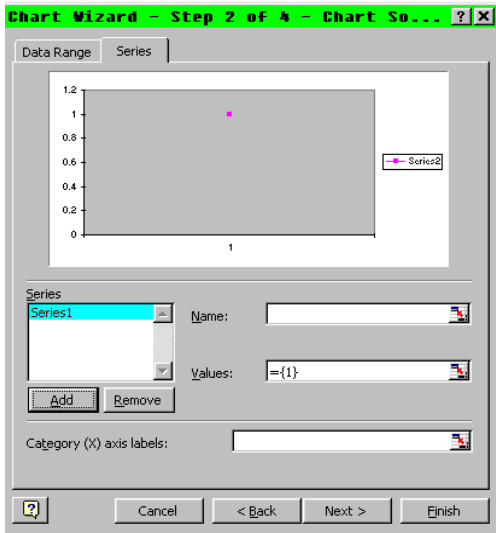

6. Click on "Add" – Series box will display "Series 1" and Blank Graph will appear.
7. "Series 1" will be replaced by name in the Name box. Click the Name box and type in "Current loss mB/m"
8. In the "Category (X) axis labels", Click on the small red arrow: The box will change into a long rectangular box Chart Wizard – step 2 of 4 – "Chart so..."

	A	B	C	D	E	F	G	H	I	J	K	L	M	N	
1	PCM Receiver Datalog Upload File - September 7 99 17:28:16														
2															
3	Log	Distance	4Hz	4Hz	Direction	Depth	Loss								
4	Number		(mA)	(dBmA)		(cm)	(mB/metre)								
5															
6															
7		1	0	293.3	49.35	Undefined	66	0							
8		2	25	273.5	48.74	Reverse	64	24.4							
9		3	50	265	48.46	Reverse	63	11.2							
10		4	75	263.5	48.42	Reverse	62	1.6							
11		5	100	260.1	48.3	Reverse	63	4.8							
12		6	125	257.4	48.21	Reverse	60	3.6							
13		7	150	257.3	48.21	Reverse	60	3.6							
14		8	175	257.3	48.21	Reverse	60	3.6							
15		9	200	257.3	48.21	Reverse	60	3.6							
16		10	225	257.3	48.21	Reverse	60	3.6							
17		11	250	257.3	48.21	Reverse	60	3.6							
18		12	275	257.3	48.21	Reverse	60	3.6							
19		13	300	257.3	48.21	Reverse	60	3.6							
20		14	325	246.2	47.83	Reverse	58	2							
21		15	350	246.2	47.83	Reverse	58	0							
22		16	375	245.6	47.8	Reverse	59	1.2							
23		17	400	245.3	47.79	Reverse	58	0.4							
24		18	425	239.4	47.58	Reverse	57	8.4							

9. On the worksheet, highlight/click, and drag Distance column B – this data will appear in this box.

	A	B	C	D	E	F	G	H	I	J	K	L	M	N	
1	PCM Receiver Datalog Upload File - September 7 99 17:28:16														
2															
3	Log	Distance	4Hz	4Hz	Direction	Depth	Loss								
4	Number		(mA)	(dBmA)		(cm)	(mB/metre)								
5															
6															
7		1	0	293.3	49.35	Undefined	66	0							
8		2	25	273.5	48.74	Reverse	64	24.4							
9		3	50	265	48.46	Reverse	63	11.2							
10		4	75	263.5	48.42	Reverse	62	1.6							
11		5	100	260.1	48.3	Reverse	63	4.8							
12		6	125	257.4	48.21	Reverse	60	3.6							
13		7	150	257.3	48.21	Reverse	60	3.6							
14		8	175	257.3	48.21	Reverse	60	3.6							
15		9	200	257.3	48.21	Reverse	60	3.6							
16		10	225	257.3	48.21	Reverse	60	3.6							
17		11	250	257.3	48.21	Reverse	60	3.6							
18		12	275	257.3	48.21	Reverse	60	3.6							
19		13	300	257.3	48.21	Reverse	60	3.6							
20		14	325	246.2	47.83	Reverse	58	2							
21		15	350	246.2	47.83	Reverse	58	0							
22		16	375	245.6	47.8	Reverse	59	1.2							
23		17	400	245.3	47.79	Reverse	58	0.4							
24		18	425	239.4	47.58	Reverse	57	8.4							
25		19	450	238	47.53	Reverse	54	2							
26		20	475	230.1	47.24	Reverse	128	11.6							
27		21	500	229.6	47.22	Reverse	58	0.8							
28		22	525	222.6	46.99	Reverse	117	9.2							
29		23	550	212.6	46.72	Reverse	32	3.2							
30		24	575	202.6	46.45	Reverse	27.6	2.6							

10. Click on the small red icon in this box, and the data will reappear in the category (X) axis labels, and the graph will have a square dot or part filled on it.
11. Click on the small red arrow icon in 'values' box. This shows = {1}
12. The long rectangular box shows "Source Data-Values"

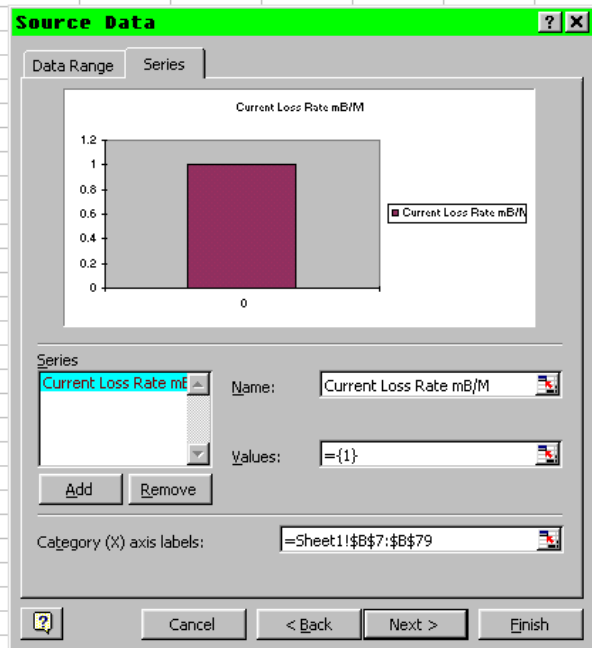

Pipeline Current Mapper User Guide

Section 12

5								
6								
7	1	0	293.3	49.35	Undefined	66	0	
8	2	25	273.5	48.74	Reverse	64	24.4	
9	3	50	265	48.46	Reverse	63	11.2	
10	4	75	263.5	48.42	Reverse	62	1.6	
11	5	100	260.1	48.3	Reverse	63	4.8	
12	6	125	257.4	48.21	Reverse	60	3.6	

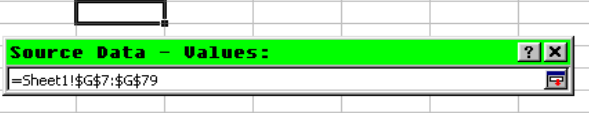
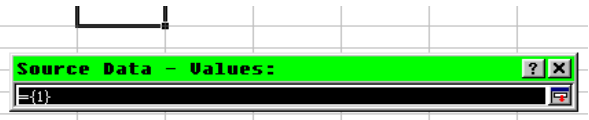

13. Highlight/click and drag the loss(mB/metre) column G. These values will appear in the box. Click on the small red icon.

	A	B	C	D	E	F	G
1	PCM Receiver Datalog Upload File - September 7 '99 17:28:16						
2							
3	Log	Distance	4Hz	4Hz	Direction	Depth	Loss
4	Number		(mA)	(dBmA)		(cm)	(mB/metre)
5							
6							
7	1	0	293.3	49.35	Undefined	66	0
8	2	25	273.5	48.74	Reverse	64	24.4
9	3	50	265	48.46	Reverse	63	11.2
10	4	75	263.5	48.42	Reverse	62	1.6
11	5	100	260.1	48.3	Reverse	63	4.8
12	6	125	257.4	48.21	Reverse	60	3.6
13	7	150	257.3	48.21	Reverse	62	0
14							3.6
15							1.2
16							0.8
17							5.6
18							0.8
19							1.2
20	14	325	249.2	47.83	Reverse	58	2
21	15	350	246.2	47.83	Reverse	58	0
22	16	375	245.6	47.8	Reverse	59	1.2
23	17	400	245.3	47.79	Reverse	58	0.4
24	18	425	239.4	47.58	Reverse	57	8.4
25	19	450	238	47.53	Reverse	54	2
26	20	475	230.1	47.24	Reverse	128	11.6
27	21	500	229.6	47.22	Reverse	58	0.8
28	22	525	223.6	46.99	Reverse	117	9.2
29	23	550	204	46.19	Reverse	49	32

14. The graph now shows Distance on (X) axis and Loss (mB/metre) on (Y) axis

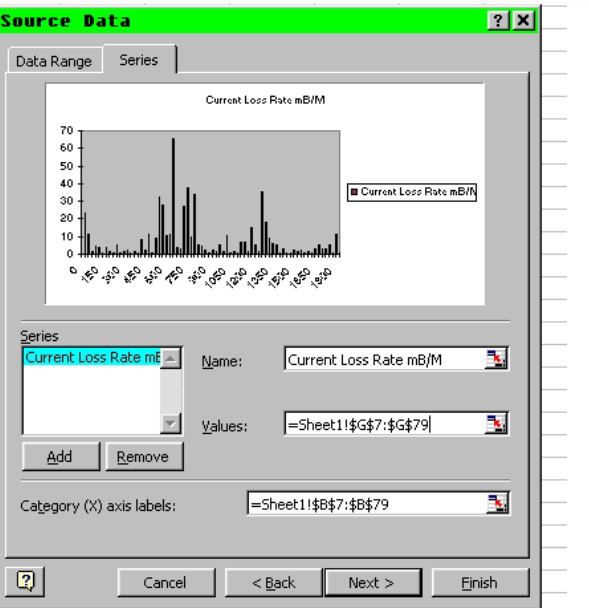

	A	B	C	D	E	F	G
1	PCM Receiver Datalog Upload File - September 7 '99 17:28:16						
2							
3	Log	Distance	4Hz	4Hz	Direction	Depth	Loss
4	Number		(mA)	(dBmA)		(cm)	(mB/metre)
5							
6							
7	1	0	293.3	49.35	Undefined	66	0
8	2	25	273.5	48.74	Reverse	64	24.4
9	3	50	265	48.46	Reverse	63	11.2
10	4						1.6
11	5						4.8
12	6						3.6
13	7						0
14	8						3.6
15	9						1.2
16	10						0.8
17	11						5.6
18	12						0.8
19	13						1.2
20	14						2
21	15						0
22	16						1.2
23	17						0.4
24	18	425	239.4	47.58	Reverse	57	8.4
25	19	450	238	47.53	Reverse	54	2
26	20	475	230.1	47.24	Reverse	128	11.6
27	21	500	229.6	47.22	Reverse	58	0.8
28	22	525	223.6	46.99	Reverse	117	9.2
29	23	550	204	46.19	Reverse	49	32
30	24	575	188.4	45.5	Reverse	111	27.6
31	25	600	182.9	45.24	Reverse	87	10.4
32	26	624	177.2	44.97	Reverse	32	11.25
33	27	650	145.7	43.77	Reverse	97	65.38467

15. Click on 'Add'-series box shows series 2 and values box shows {1}. Name the series in the "Name" box "Current loss rate mB/m".

16. Click on the small red icon, the long rectangular box shows 'Source Data-Values'.

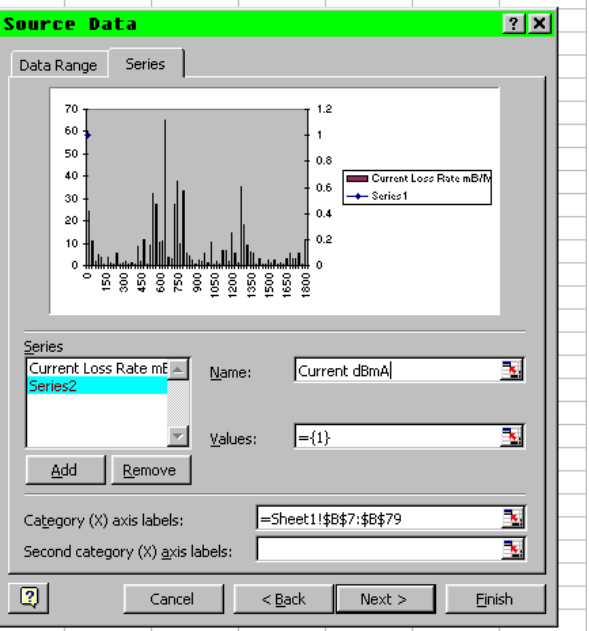

Pipeline Current Mapper User Guide

Section 12

5																	
6																	
7	1	0	293.3	49.35	Undefined	66	0										
8	2	25	273.5	48.74	Reverse	64	24.4										
9	3	50	265	48.46	Reverse	63	11.2										
10	4	75	263.5	48.42	Reverse	62	1.6										
11	5	100	260.1	48.3	Reverse	63	4.8										
12	6	125	257.4	48.21	Reverse	60	3.6										

Source Data - Values: [?] [X]
 =Sheet1!\$D\$7:\$D\$79

17. On the worksheet Highlight/Click and drag Current 4Hz (dBmA) column D. The data will appear in the box. Click on the small red icon.

1	PCM Receiver Datalog Upload File - September 7 '99	17:28:16															
2																	
3	Log	Distance	4Hz	4Hz	Direction	Depth	Loss										
4	Number		(mA)	(dBmA)		(cm)	(mB/metre)										
5																	
6																	
7	1	0	293.3	49.35	Undefined	66	0										
8	2	25	273.5	48.74	Reverse	64	24.4										
9	3	50	265	48.46	Reverse	63	11.2										
10	4	75	263.5	48.42	Reverse	62	1.6										
11	5	100	260.1	48.3	Reverse	63	4.8										
12	6	125	257.4	48.21	Reverse	60	3.6										
13	7						0										
14	8						3.6										
15	9						1.2										
16	10						0.8										
17	11						5.6										
18	12						0.8										
19	13						1.2										
20	14						2										
21	15						0										
22	16						1.2										
23	17						0.4										
24	18						8.4										
25	19						2										
26	20						11.6										
27	21	500	229.6	47.22	Reverse	58	0.8										
28	22	525	223.6	46.99	Reverse	117	9.2										
29	23	550	204	46.19	Reverse	49	32										
30	24	575	188.4	45.5	Reverse	111	27.6										

Source Data [?] [X]

Data Range: [] Series: []

Series: Current Loss Rate mB/M, Current dBmA

Name: Current dBmA

Values: =Sheet1!\$D\$7:\$D\$79

Category (X) axis labels: =Sheet1!\$B\$7:\$B\$79

Second category (X) axis labels: []

[?] [Cancel] < Back Next > Finish

18. Now the values are shown and the graph now has 2 (Y) axes
19. Click on the small red icon in the "secondary category (X) axis labels" box. On the worksheet highlight/click and drag distance column B. This data will appear in the rectangular box.

20. Click on 'Next'-Chart wizard step 3 of 4-Chart options-This stage is for Titles, Axes, grid lines, legends etc.

Type these in now

The Title will appear at the top of the graph example.

In 'Category (X) Axis' type in "Distance Metres".

In 'Value (Y) Axis' type in "Current Loss Rate mB/M".

In 'Second Value (Y) Axis' type in "Current dBmA".

These will appear on the graph example. Click on 'Next'.

Chart Wizard - Step 3 of 4 - Chart Options [?] [X]

Titles | Axes | Gridlines | Legend | Data Labels | Data Table

Chart title: Simulation Gas Pipeline

Category (X) axis: Distance Metres

Value (Y) axis: Current Loss rate mB/M

Second category (X) axis: []

Second value (Y) axis: Current dBmA

[?] [Cancel] < Back Next > Finish

Pipeline Current Mapper User Guide Section 12

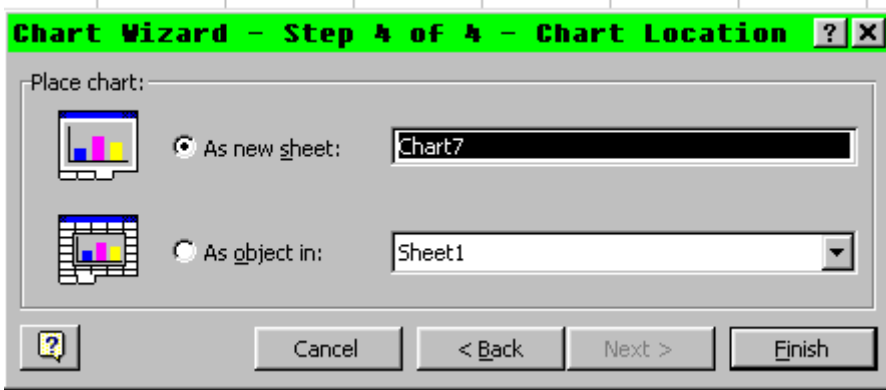

21. Chart Wizard- Step 4 of 4- Chart location

The chart can be placed as a new sheet (which is preferable), or as an object in the worksheet.

Click on the 'New Sheet' point. Then Click on 'Finish' the graph. will appear.

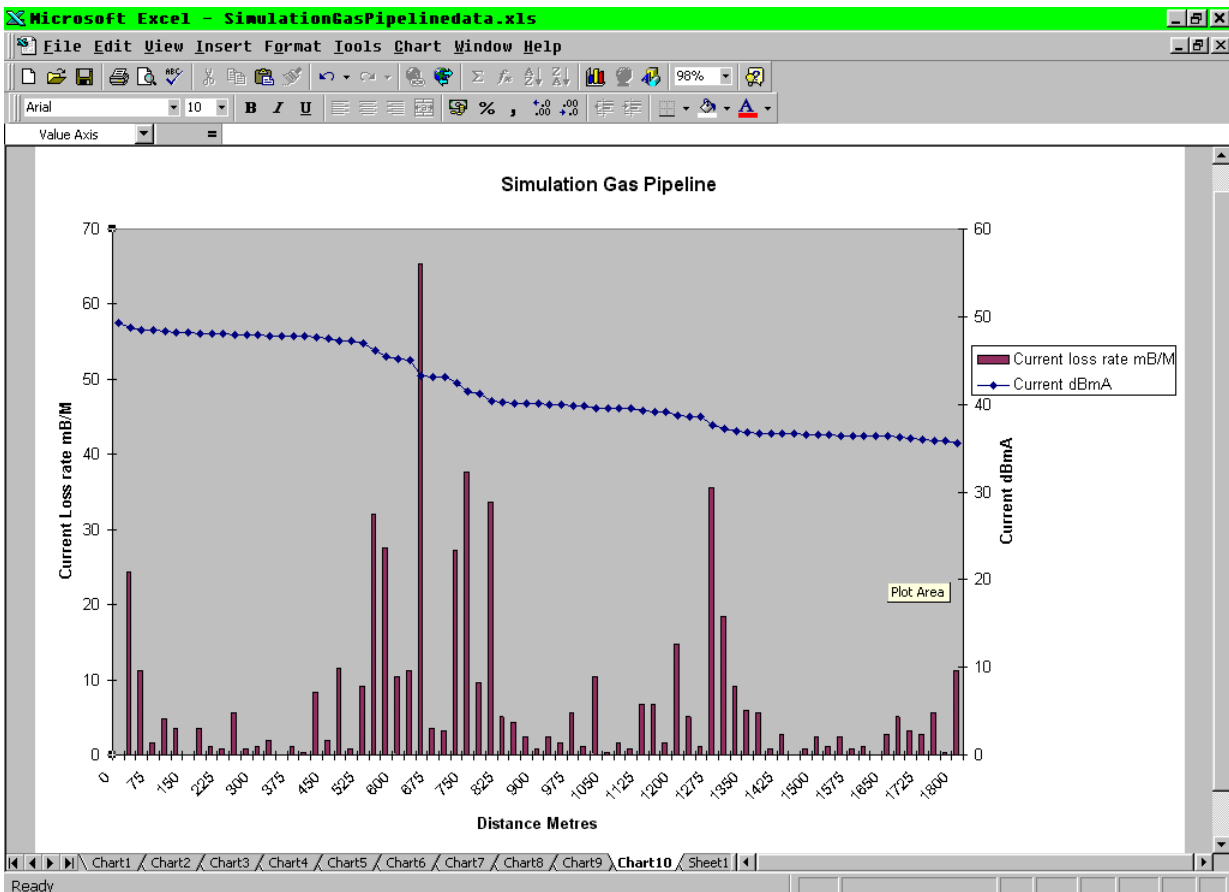

22. The next stage is to improve the appearance of the graph, and make it easier to interpret. The dB mA current does not need full scale from zero to maximum and this can be changed.

Pipeline Current Mapper User Guide

Section 12

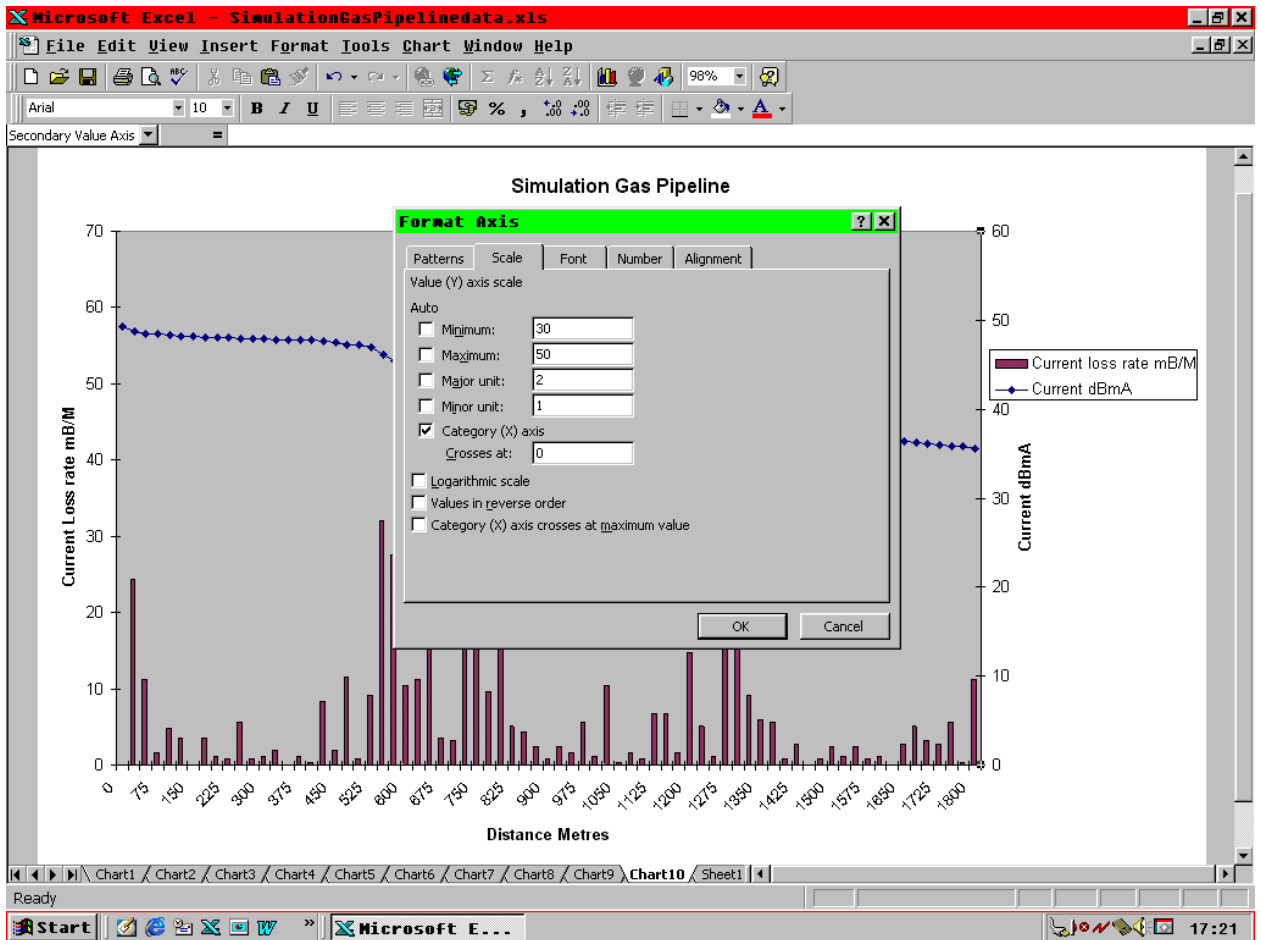

23. Double Click on the numbers beside the Current dBmA (Value/Y2) axis. This shows the 'Format Axis' box. From the menu tabs, click on 'Scale'. Change the maximum and minimum values and the major and minor units – this will allow the curve/slope of the graph of the current loss to be steeper and makes the faulty sections easier to observe.

Pipeline Current Mapper User Guide

Section 12

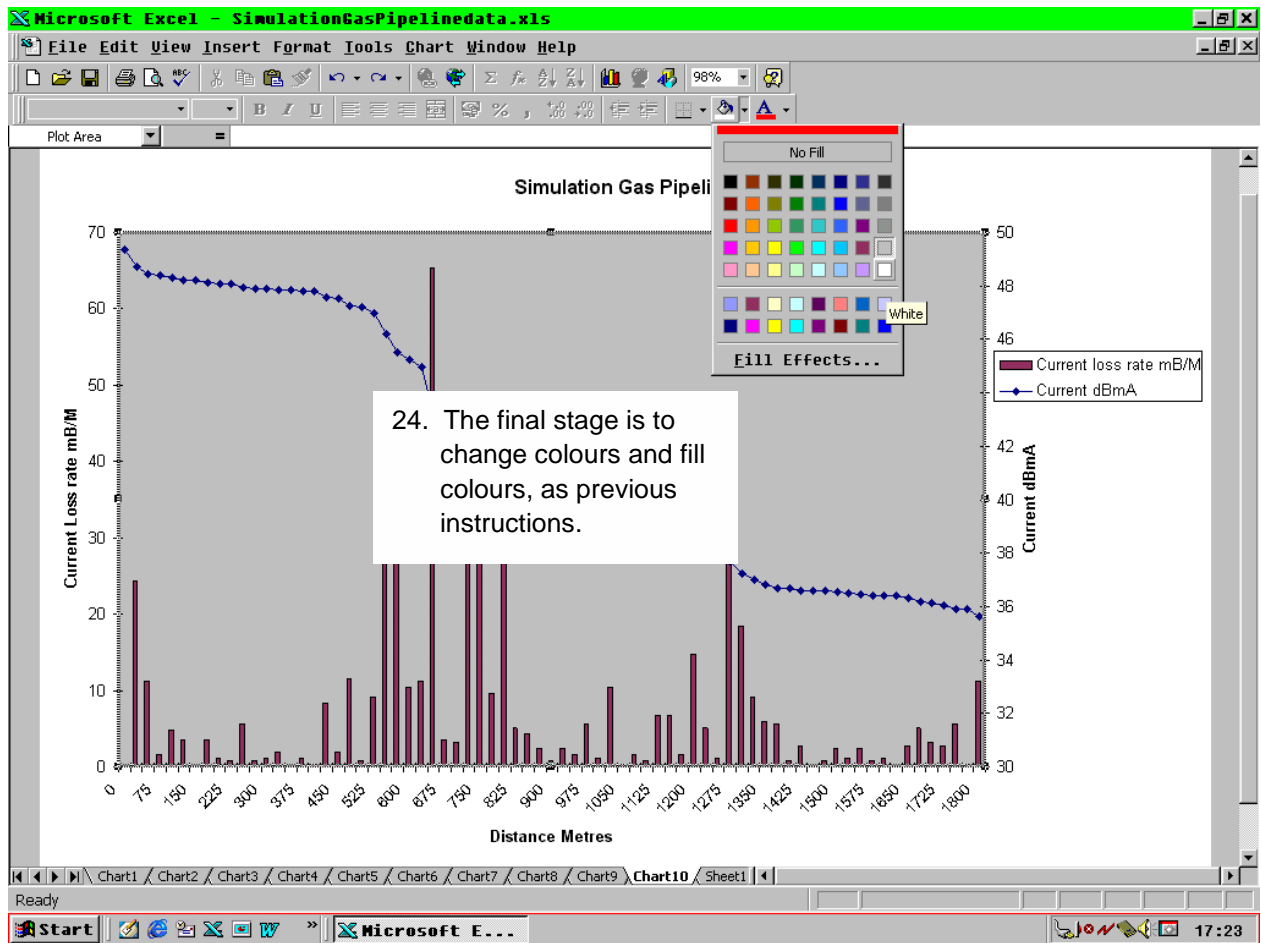

Pipeline Current Mapper User Guide

Section 13

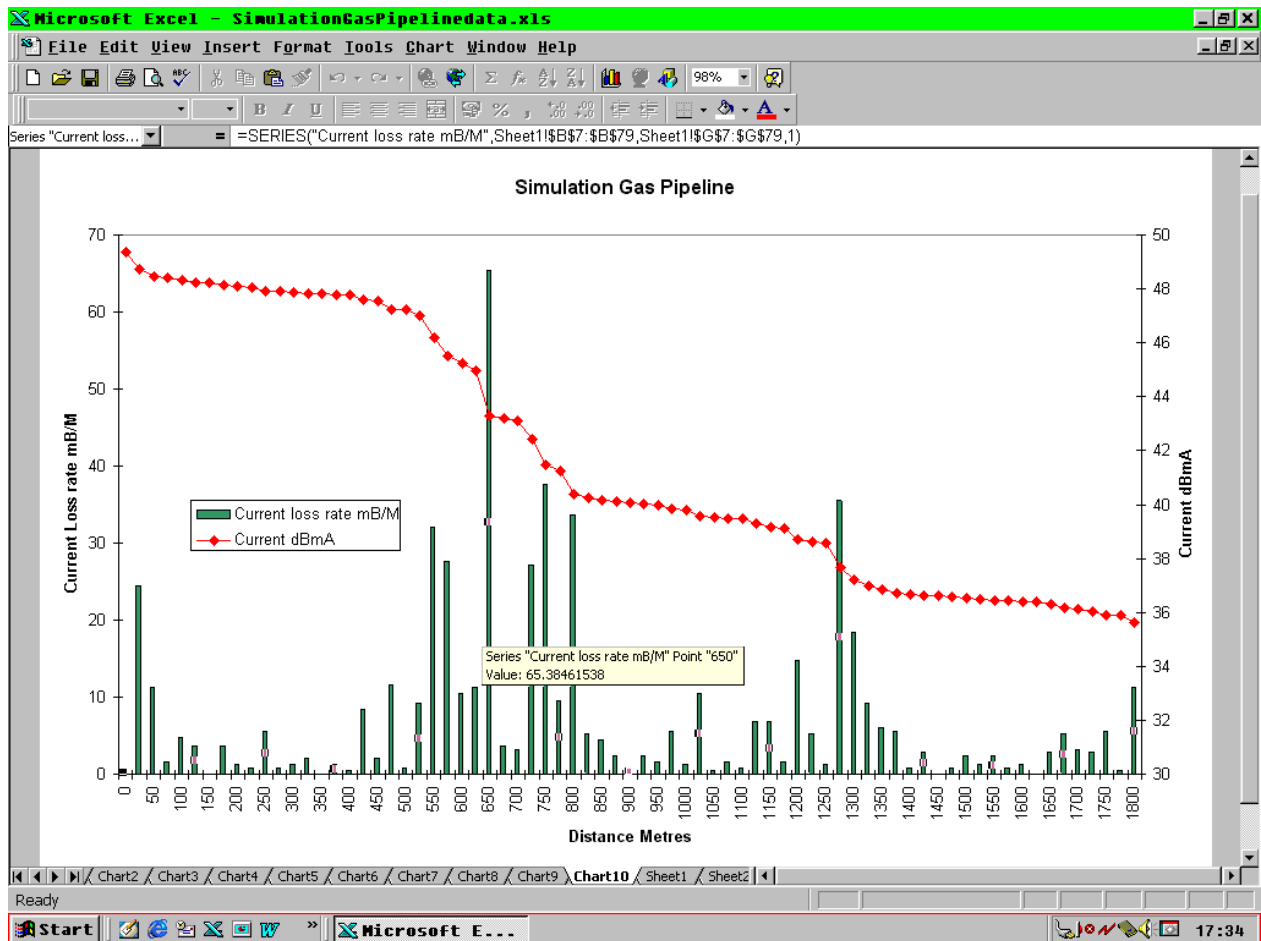

The finished graph

Pipeline Current Mapper User Guide

Section 13

Using the PCM system with GPS and Dataloggers.

Global Positioning Systems (GPS) are increasingly used to provide location references for surveyors. Recently GPS systems have become more accurate and less costly to purchase.

Making a PCM survey with GPS means that the results can be combined with a Geographical Information System (GIS), providing very useful information for defect analysis and simplifying future comparison of survey results.

All Radiodetection PCM and RD400 locator receivers with a RS232 socket can provide output to GPS and Dataloggers.

Below are explanations of the data transmission protocol, describing use with different dataloggers and special set up instructions for the Trimble pathfinder TDC1 and TSC1 GPS systems. Full configuration and operating instructions for the Trimble GPS Pathfinder Pro XR, Pro XRS, and Power systems are given at Appendix 1.

System Overview

The RS232 port fitted to the receivers allows the operator to log measurement operations carried out by the receiver.

If connected to a PSION LZ 64 type datalogger a complete update is transmitted at 2400 baud whenever a key is pressed or the gain altered, ensuring that no operations are lost. This system does not provide PCM current data.

If connected to any other datalogger which appears as a DTE a complete update is transmitted whenever the Shift + Depth keys are pressed, providing that depth is still on the screen, and no more than 6 seconds has elapsed since performing a Depth or Current Measurement.

With a PCM, the data is transmitted when the PCM current reading is accepted with the "check" key (even if the internal PCM datalogger is full). This provides compatibility with GPS based dataloggers and ensures that only user-requested operations are logged. Typical datalogger types are Psion Workabout and Trimble TDC 1 and TDC2. This system provides 4 different data streams, all at 19200 baud.

Mechanical and Electrical connection.

The RS232 socket used is as follows: IBM PC style D-shell 9-way socket.

The hardware used by the RD400 Series 2 and series 4 Locators satisfies the EIA electrical requirement for RS232D signals with limited handshaking. The minimum signals required are TXD, RXD and Ground. The pin number and intended destination at the DTE are shown below:-

- Pin 1 = DCD
- Pin 2 = RXD
- Pin 3 = TXD
- Pin 4 = DTR
- Pin 5 = GND
- Pin 6 = DSR
- Pin 7 = RTS
- Pin 8 = CTS
- Pin 9 = Open circuit

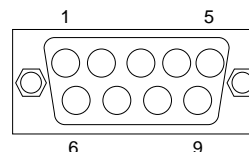

Pipeline Current Mapper User Guide

Section 13

Interface

Connection to DTE

The locator is implemented as a DCE and provides the necessary handshaking signals required by an external system configured as a DTE. The Locator loops back the DTE control signals as follows: DCD, DTR and DSR linked together. RTS and CTS linked together. Data transmission does not require handshaking.

A direct pin to pin connection between the locator and DTE will provide the correct interface in situations that require the F00 data format (see below). This provides compatibility with the PSION LZ64 system, operating at 2400 baud.

For all other data formats it will be necessary to de-assert DTR by using a modified connecting cable, which is made by removing Pin 4 from the 9 Pin female plug on a standard 9 Pin RS232 connecting lead (see diagram above). This switches the PCM data output to 19200 baud and the locator behaves like it does when connected to a DCE system.

Connection to DCE

A three wire system using TXD, RXD and GND is used, allowing a direct pin to pin connection between the locator and DCE to provide the correct interface.

Data Format

In order to conserve power the locator RS232 interface will remain in an inactive state except when data transmission is being made.

The data format depends on the implementation of the external system.

For RD400 Series 2 locators only:- If the external system appears as a DTE (e.g. PSION system) which asserts DTR then the data will be transmitted at 2400BPS with eight data bits, no parity and one stop bit. A line of the data will be transmitted when any front panel key is pressed. The data string will be in format F00 as defined below.

If the external system is a DCE (or uses a 3 wire system) and does not assert DTR then the data will be transmitted at 19200 BPS with eight data bits, no parity and one stop bit. A line of the data will be transmitted when Shift-Depth is pressed.

An entire line will be transmitted in 1 second and will represent the state of the receiver at the time when the depth or current measurement was performed.

The data consists of an identifying Format Reference number (Fxx) followed by the data string. The Reference number identifies the following data string so that the receiving computer system can identify the data type.

Format Reference.	Connection	Description
F00	DTE	Data (not PCM) output for 2400 Baud Psion type LZ64 and Trimble GPS type TSC1.
F02	DCE	Data and PCM output for 19200 Baud Psion workabout, Trimble GPS type TDC1 and TDC2.
F04	DCE	Data and PCM output for 19200 Baud Psion workabout, Trimble GPS type TDC1 and TDC2.

Pipeline Current Mapper User Guide

Section 13

Format F02

Use with PCM software versions 1.02, 1.03, 4.00, 4.01, 4.02,4.03, 4.04, 4.05, 5.00, 5.01, 5.02. Production up to July 2001.

The F02 format provides the most useful transmitted data, and this system is the preferred method for PCM data.

The standard format of the string F02 is as follows :-

**F02,Line_number,Mode_type,Frequency,gain,signal,mode,response,
volume,battery,Depth,Current,CD_direction,FF_direction,FF_Current,4Hz_Current,
4Hz_Current_Direction,CR,LF**

The data string will consist of the Format Reference F02, followed by the data information :-

i) A line number.

The line number will be a number in the zero to 9999 range. i.e. [0000..9999]. The line number will begin at 0000 at switch-on.

ii) The type of Mode.

The type of Mode will be one of the following ASCII strings, denoting the type of mode currently in operation:

ACTIVE, CD, PCM FF, PASSIVE, POWER.

iii) The currently selected frequency.

The frequency will consist of a number which represents the operating frequency in Hz. In Power, Radio and Passive modes the frequency will be approximately the band centre frequency.

iv) The gain.

The gain will be a number in the 8 to 100 range i.e. [008-100].

v) The received signal strength.

The received signal will be in the range [000-999] or will be set to --- if the depth or current is to be displayed.

vi) The Line or Sonde Mode.

The mode will be indicated by the upper case letters L or S for Line or Sonde modes.

vii) The aerial response i.e. Peak or Null.

The response will be indicated by the upper case letters P or N for Peak or Null modes.

viii) A number indicating the volume setting.

The Volume setting will be in the range [0-3]

Where 0 = Off, 1 = Minimum Volume, 2 = Medium Volume, 3 = Maximum Volume.

ix) The battery voltage in levels.

The battery level will be in the range [0-4]

Where 0 = Battery Empty, 1 = 25% Full, 2 = 50% Full, 3 = 75% Full, 4 = 100% Full

Pipeline Current Mapper User Guide

Section 13

x) The Depth.

The depth and current will be displayed if either the depth or current buttons have been pressed and a valid reading obtained. If the receiver is configured for metric measurement the reported format will be as follows :-

The metric measurement will be in the form M,[0.00-9.99] which is the depth in metres. The "M," preceding the number denotes Metric measurement.

If the receiver is in the Imperial mode of measurement the depth will be reported as follows :-

The parameters will be in the form I,[00.0-15.0]. This represents feet to the left of the decimal point and inches to the right. The inches are displayed up to 9. If the number of inches is greater than 9 the feet are incremented by one and the inches set to zero. The "I" preceding the number denotes imperial measurement.

xi) The Current.

Current is displayed with either mA or dB microamps scaling as set by the receiver's LCD set up..

xii) The CD current direction. (PCM Version –CT only)

The current direction will only be displayed if the CD button has been pressed and a result obtained. The current direction will be one of the following:-

fd = Forward
bk = Backward
no = No current direction.

xiii) The Fault direction.

The Fault-find direction is displayed in the same way as CD

fd = Forward
bk = Backward
no = No current direction.

xiv) Fault Find Current.

Fault find current is displayed in dB microvolts

xv) 4 Hz PCM Current.

Current is displayed with either mA or dB scaling as set by the receiver's LCD set up.

xvi) 4 Hz Current Direction.

The 4Hz current direction will be one of the following:-

fd = Forward
bk = Backward
no = No current direction.

Pipeline Current Mapper User Guide

Section 13

Examples of Parameters F02 format.

Four different outputs can be provided by the PCM when using DCE interface at 19200 Baud.

1. In the normal locate mode, the full screen information is transmitted when Shift and Depth keys are pressed.

F02,0001,ACTIVE,128HZ,032,629,L,P,0,4, , , , , , , ,

2. When locate Depth or locate Current is required, either Depth or Current keys are pressed. When the Depth or Current is displayed on LCD, Pressing Shift and Depth will transmit both Depth and Current to the datalogger.

F02,0002,ACTIVE,128HZ,032,---,L,P,0,4,M,1.29,0.52A, , , , ,

3. When the PCM magnetometer foot is activated to display a 4 Hz Pipeline Current reading, and then the result is saved by a second press of the PCM Check key, the data is saved in the magnetometer foot, It is also transmitted to the datalogger.

F02,0003,ACTIVE,128HZ,033,---,L,P,0,4,M,1.29, , , ,490mA,bk,

Please note that software versions 4.00, 4.01, 4.02, 4.03, 4.04, 4.05, 5.00 and 5.01 do not transmit depth reading at the same time as PCM reading. Versions 1.02, 1.03 and 5.02 transmit complete information as above. Depth is always saved in the PCM's magnetometer foot.

4. If the PCM is used with the accessory A Frame plugged in to the accessory socket, and the result is saved in the PCM receiver by pressing the Shift and Depth keys and the readings will also be transmitted to the datalogger.

FO2,0004,PCMFF,8HZ,--,---,L,P,0,4, , , , ,fd, , ,073dB

In examples 2 and 3 Depth will be in either Metric or Imperial units as defined in paragraph (x) above, depending on the PCM receiver LCD set up. Current Measurement units will be either in mA or dB depending on the receiver LCD set up. To change PCM receiver LCD setup see section 10 page 37.

In each case the end of line is followed by carriage return (CR) and line feed (LF)

Format for PCM (F04)

Use with PCM software versions 5.03 onwards. Production after July 2001.

The F04 format provides the most useful transmitted data, and this system is the preferred method for PCM data.

The standard format of the string is as follows :-

**F04,Line_number,Mode_type,Frequency,gain,signal,mode,response,
Depth_unit,Depth,Current_unit_mA,Current_mA,Current_unit_dB,Current_dB,
CD_current_direction,Fault_direction,4Hz_Current_unit_mA,4Hz_Current_mA,
4Hz_Current_unit_dB or Fault_unit_dB,4Hz_Current_dB or Fault_Voltage_dB,
4Hz_Current_direction,CR,LF**

Pipeline Current Mapper User Guide

Section 13

The data string will consist of the Format Reference F04, followed by the data information :-

i) A line number.

The line number will be a number in the zero to 9999 range. i.e. [0000..9999]. The line number will begin at 0000 at switch-on.

ii) The type of Mode.

The type of Mode will be one of the following ASCII strings, denoting the type of mode currently in operation:

ACTIVE, CD, PCM FF, PASSIVE, POWER.

iii) The currently selected frequency.

The frequency will consist of a number that represents the operating frequency in Hz. In Power, Radio and Passive modes the frequency will be approximately the band centre frequency.

iv) The gain.

The gain will be a number in the 8 to 100 range i.e. [008-100].

v) The received signal strength.

The received signal will be in the range [000-999] or will be set to --- if the depth or current is to be displayed.

vi) The Line or Sonde Mode.

The mode will be indicated by the upper case letters L or S for Line or Sonde modes.

vii) The aerial response.

The response will be indicated by upper case letters as follows.

P	Peak
N	Null
M	Standard accessory
A	A Frame
C	CM Clamp
D	Double Depth antenna
S	CD Stethoscope

viii) Depth units.

ix) Depth.

If either the depth key or the current key has been pressed and a valid reading obtained the depth will be transmitted. The depth will be in the range 000 to 999 cm if the receiver is configured for metric measurement. The depth will be in the range 000 to 180 inches if the receiver is configured for Imperial measurement.

x) Current units mA.

xi) Current in mA.

xii) Current units dB.

xiii) Current in dB (microamps) *

*Note: Software version 5.04 produces current in dB milliamps

The current will be transmitted with both mA and dB scaling.

Pipeline Current Mapper User Guide

Section 13

2. When locate Depth or locate Current is required, either Depth or Current keys are pressed. When the Depth or Current is displayed on LCD, Pressing Shift and Depth will transmit both Depth and Current to the datalogger.

F04,0002,ACTIVE,128Hz,037,---,L,P,cm,145, mA,103.68,dB,100.31, , , , , , ,CR,LF

Using Imperial Depth settings for LCD display;

F04,0003,ACTIVE,98Hz,034,---,L,P,inches,50, mA,269.43,dB,108.61, , , , , , ,CR,LF

Version –CR with CPS frequency;

F04,0004,ACTIVE,100Hz,046,---,L,P,cm,112, mA,99.35,dB,99.94, , , , , , ,CR,LF

3. When the PCM magnetometer foot is activated to display a 4 Hz Pipeline Current reading, and then the result is saved by a second press of the PCM Check key, the data is saved in the magnetometer foot, It is also transmitted to the datalogger.

F04,0005,ACTIVE,128HZ, ,---,L,P,cm,89, , , , , , mA,272.20,dB,108.70,bk,CR,LF

Using Imperial Depth settings for the LCD display;

F04,0006,ACTIVE,98Hz,034,---,L,P,inches,43, , , , , , mA,268.72,dB,108.59,bk,CR,LF

4. If the PCM is used with the accessory A Frame plugged in to the accessory socket, and the result is saved in the PCM receiver by pressing the Shift and Depth keys and the readings will also be transmitted to the datalogger.

FO4,0007,PCMFF,8HZ, , , ,A, , , , , , , fd, , ,dB,63.41,CR,LF

In examples 2 and 3 Depth will be in either Metric or Imperial units as defined in paragraphs (vii and ix) above, depending on the PCM receiver LCD set up. Current Measurement units will be displayed in mA and dB.

Please note that the PCM receiver LCD scale values will depend on the receiver setup. To change the LCD display settings, please see section 10, page 37 of this manual.

In each case the end of line is followed by carriage return (CR) and line feed (LF)

Pipeline Current Mapper User Guide

Section 13

Set up instructions for Trimble GPS systems.

Configuration of Trimble TDC1 Data Logger with External Sensor (PCM Rx.)

Check the integrity of all connections to the equipment, that is, Antenna, RD400 Receiver, Datalogger (TDC1), and batteries.

Switch the TDC1 on.

Under the *Main Menu*, select *Data Capture*.

Under the *Data Capture* menu, select *Create Rover File*.

This will display the *Create File* screen. Within this screen the user can change the name of the new rover file and can also choose the appropriate data dictionary for use whilst collecting GPS positions. Press *OK* to reveal the *Start Feature* menu. Press *F4* to select *EXT* from the extra menus at the bottom of this screen.

Pressing *F4* displays the *Select Sensor* menu. From this menu choose *Sensor 1* and a tick should appear to mark its selection. Press *F1* to select *Setup* from the extra menus at the bottom of this screen.

This will display the *Setup Screen* for sensor 1. Adjust the settings as follows:

Sensor 1

Auto connect:Yes

Name:PCM (or name of choice)

Channel:0

Connect:\01

Disconnect:\04

Data request:?

Intervals

Point feature:All

Line/area:All

Not in feature:All

Attribute:None

Data received

Prefix:?

Suffix:LF

Max bytes?

Time-out:0.100s

Audible click:Yes

Status line:No

Another important thing to check, is the logging interval. To do this, use the *Clear* button to get back to the *Start Feature* menu. From this menu, press the *Func* and *GPS* buttons together.

This will display the *Configuration* menu; select *GPS* and press *Enter*, to reveal the *Configure GPS* menu. Select *Rover Options* and press *Enter* to reveal the *Rover Options* screen. Set the logging intervals to maximum, that is 3600s and press *OK*. The configuration will be saved and the *Configure GPS* menu will re-appear. Press the *Clear* button to return to the *Configuration Menu*. Press the *Clear* button again to return to the *Start Feature* menu.

Pipeline Current Mapper User Guide

Section 13

Under the *Start Feature* menu press *F4* to select *EXT*, then press *F3* to reveal the *Status* screen. This will show any data that comes from the PCM receiver as well as the number of GPS positions logged.

The TDC1 can stay in this screen for the period of the PCM survey.

The TDC1 will receive data when the PCM saves a 4Hz measurement in the data log.

This data is transferred through the RS232 port on the back of the PCM Receiver. However, the TDC1 will initiate two GPS measurements at the same time, which it stores with the PCM data to create a record.

Pipeline Current Mapper User Guide

Section 13

PCM as 'External Sensor' for TSC1 with Asset Surveyor Software

Version 2.1 - August 8, 2000

This application note is designed to guide users, sales and support staff through connecting a Trimble TSC1 collector (TSC1) with Asset Surveyor software to a Radiodetection Pipeline Current Mapper (PCM), for the purposes of using the PCM to aid the mapping technician in gathering accurate positional data of buried utilities for inclusion into a Geographic Information System (GIS). These two products together also aid the corrosion technician with very accurate distance measurements between PCM readings for accurate current loss / distance measurements.

Trimble Survey Controller Software (not Asset Surveyor) in the data collector is currently not supported as that software does not allow external sensors to be added.

With practice, users will find this system is a fast, convenient, and accurate method of collecting data.

Several steps are required, including setting up the Trimble Data Dictionary (TDD), setting up the PDL as an external sensor and connecting the PDL to the TSC. The basic of gathering data is also included. Future developments may include a predefined setup in the TSC1 to make the configuration an easy, one-step process.

IMPORTANT NOTE: The PCM sends out several different measurements including: current in milliamperes (mA), depth, and current direction. The TSC1/Asset Surveyor is not capable of getting each of these information fields and separately storing them. The user has 2 choices: copy all the information into a text data field where the user has to break it up, or copy just one of the numeric data fields (PCM current OR depth) into a numeric data field. If it is stored as text data, there may be a possibility of the PC software, Pathfinder Office (PFO) being able to break it up.

- 1) To properly set up the Data Dictionary to accept the PCM data, you must include a new feature (F3) of type Point and a Feature name of 'Depth Point' or 'Current Point' or generically "PCM Data" or similar in the TDD. Within that feature, a new attribute (F7) of either Numeric or Text has to be defined based on the information in the important note above.

If Numeric, it must have the following settings:

- Atttribute Name of 'Depth', 'Current' or similar.
- Comments as desired
- Decimal Places: 2
- Minimum: 0
- Maximum: 50
- Default: 0
- Field Entry: Required or Normal (users choice)

If Text, it must have the following settings:

- Atttribute Name of 'Data' or similar.
- Comments as desired
- Length: 24 (or more)
- Field Entry: Required or Normal (users choice)

Using a numeric data type for the depth attribute will help GIS systems in to recognise the depth as a number value when analysing data to find installation problems such as too little depth of cover. Other components of the TDD would likely include a feature of type Line to mark the position of the pipe or cable being located that included attributes describing the type, nature, owner, size, pressure, etc. of the line. If multiple utilities are being located at once, multiple line (for position) and point (for depth) features would likely be required, one pair for each utility type.

Pipeline Current Mapper User Guide

Section 13

Another important part of setting up this system for data gathering is the positional data recording rate. The trade off is accuracy versus data set size. Users may be tempted to use a relatively long period between position points. While this may be adequate for a long, straight utility, the accuracy of the corner positions may be severely compromised. Nor can we assume that all corners are basically the same. Some systems such as gas pipes are typically all 90 degree elbows and "T's" and laid square to the property lines. Cables are sometimes laid diagonally or with large radius bends. If the TSC is set to record data every say 10 seconds, that may show up a sharp 90 degree bend as a longer, larger radius path. To put a number on this, if the user is walking at 1 meter per second (an average walking speed), corners could be out 5 - 9 meters with a 10 second sample rate. A more frequent recording rate of once every 1 or 2 seconds would reduce these errors substantially.

2) To properly set up the TSC to accept the PCM as an external sensor users have to enter the TSC External Sensor Setup.

Other locator data may be gathered, refer to the Radiodetection / PCM locate serial data sheet for full formats. A couple of sample strings are included here:

```
F02,0010,ACTIVE,98HZ,040,---,L,P,1,4,M,0.06,,,3.10mA,no,
F02,0011,ACTIVE,98HZ,040,---,L,P,1,4,M,0.06,,,3.20mA,no,
```

For the different data fields to record, set up next paragraph with the following values (without double quotes): NOTE: Please re-read paragraphs on previous page "IMPORTANT NOTE" and the differences between text and numeric data.

To record just depth, prefix of ",M,", suffix of "," and Max Bytes of 8.

To record just current, prefix of ",,,", suffix of "mA" and Max Bytes of 11.

To record complete text info, prefix of ",M,", suffix of "?" and Max Bytes of 24.

Auto Connect	No
Name	Radiodetection PCM
Channel	0
Connect	?
Disconnect	?
Data Request	?
Intervals	
Point Feature	All
Line/Area	All
Not in feature	All
Attribute	(Must be same as defined in Data Dictionary - CRITICAL!!)
Data Received	
Prefix	As above
Suffix	As above
Max Bytes	As above
Timeout	0.100 s
Audible Click	Yes
Status Line	Yes

Remember that most values, such as gain and battery strength will change and as such will not be suitable for use as a prefix or suffix.

Also, 'Auto Connect' may be set to yes to automatically make the RD the default external sensor. This will select it and make it active every time a data file is started.

Pipeline Current Mapper User Guide

Section 13

It is also required to change the 'Comms' setup for this external sensor with the following settings:

Serial port:	Top (typically)
Baud Rate	19200
Data Bits	8
Stop Bits	1
Parity	None

With this configuration the GPS Trimble Data Logger will receive depth data when either depth or current data is sent from the PCM as described in section 4.

3) Connecting the TSC to the PCM is quite simple, connect a Trimble cable, part number 32287-00 into the top port of the TSC and into the Radiodetection serial port. It is the same cable that connects the TSC to the GPS receiver hardware and will likely have to be purchased in addition to the GPS equipment from your vendor.

The Radiodetection locator will transmit the depth or current readings to the TSC only when the Check (Accept PCM Data) key is pressed to store the data into the PCM internal memory. Even if the PCM internal memory is full, the data will still be transmitted from the serial port.

It is recommended that the PCM be set up in metric depth mode for easiest data interpretation as the data coming out of the PCM serial port will always be in metric format. This will allow the user to easily verify the values being recorded.

4) Use of the systems together. The full scope of data collection is far beyond the intention of this application note. We will cover the basic steps of collection, pipe or cable position, and depth data.

In general, users will likely first find the start of a segment of the utility that they wish to map with the use of the PCM receiver and transmitter. Start the data capture procedure and make the Radiodetection Locator the current input source from the EXTERNAL sensor menu. The next step is to start recording the position of the pipe or cable in the TSC as a line feature. Then, within the positions of the line, depth readings would be 'nested'. Nesting is a Trimble term referring to recording one bit of information within another and is accessed with the 'Nest'. Before starting to capture the nested feature, users will likely want to Pause the gathering of the line feature to avoid having many extra points there that will clutter up the display. After pushing the Nest button, a menu comes up with features that can be nested and we wish to choose the point feature we created in the data dictionary and likely called Depth. An input line appears with the default value of the utility (that we defined in the TDD as 0). The 0 is a default so that any readings accidentally accepted with the default value will show up as obviously incorrect data. After a successful PCM reading has been taken, when the 'Check' (data accept) key is pressed, the default value is replaced with the value the PCM locator reports. If multiple depth readings are sent in, only the last one is recorded. Any other attributes of the point should also then be recorded. The user must finally press 'Enter' on the TSC to accept the data.

Users should also remember to 'Pause' the line feature position gathering if they are required to move off the path of the line to avoid traffic, take a break, etc.

5) Data Processing and Exporting into a GIS system. This is a substantial part of the processing and use of the data and what follows here is just a basic introduction of one sample application.

Data is processed as normal for data cleanup, differential correction, and file naming and archiving.

Pipeline Current Mapper User Guide

Section 13

The data export setup is configured within the Utilities/Export menu. In the upper window select corrected rover file. The "Output Folder" should contain the "export" subdirectory for the current project. "Choose an Export Setup", like "Sample ArcView Shape file Setup." Adjust the export options via the "Change Setup Options" button. If going to ArcView, use lat./long, WGS84. Hit "OK" in upper right corner. The Rover file is converted to a shape file and placed in "export" subdirectory. Open ArcView, either go to View/Add A Theme or follow opening window (1) Create a project with a new view (2) "would you like to add data to the new view?" In either case, go to project export directory under pfddata. Select and bring shape files into ArcView window view.

6) Intended Purpose

This system is intended only to assist in record keeping and system planning. It is not intended to replace onsite utility locating, measuring and verification procedures which are essential to accurate placement of new underground installations and avoidance of existing utilities.

All local city, state/provincial, and federal laws and guidelines must be followed including calling local 1-call organisations and/or facility owners.

Author:

Gord Parker

Applications Specialist, Western Canada

Radiodetection Canada Ltd.

Ph.: 403-281-1808, Fax.: 403-281-1828

Website: <http://www.radiodetection.ca>

Email: gord.parker@radiodetection.spx.com

Pipeline Current Mapper User Guide

Section 14

Product Group	PCM	PCM	PCM	PCM	PCM
Product Code	- CP	- CO	- CR	- CS	- CT
Product Description	PXL-2	PXL-2	PXL-2	PXL-2	PDL-2
Frequency selection					
Power – Standard	60Hz	50Hz	50Hz	60Hz	50Hz
ELF	98	128	128	98	128
CD					320
LF	512	640	640	512	640
Custom Frequency CPS	120Hz	100Hz	100Hz	120Hz	100Hz
Product features					
Depth – Active mode	#	#	#	#	#
Scaling – Line	#	#	#	#	#
Current measurement	#	#	#	#	#
Aerials – Peak mode	#	#	#	#	#
Left/Right Null mode	#	#	#	#	#
CDR –Standard					#
PCM Fault Find	#	#	#	#	#
Variable Volume Speaker	#	#	#	#	#
CPS Depth measurement	#	#	#	#	#
CPS Current measurement			#	#	#
GPS compatible Data Logging	#	#	#	#	#
PCM Data Logging	#	#	#	#	#
Data and Connection sockets					
RS232 Socket	#	#	#	#	#
Accessory socket	#	#	#	#	#
Headphone socket	#	#	#	#	#
Gain control paddle	#	#	#	#	#
Accessories (Optional)					
Ni-Cad battery pack	Opt				
Display backlight	Opt				
Accessory A Frame	10/AC1793				

Product Group	PCM Transmitter				
Part number – standard or removable lid	52/PM1748 - ?? 52/PM1748 – RL - ??				
	- USA	- EURO	- EURO	- USA	- EURO
Mains power supply	60Hz 110V	50Hz 220/230V	50Hz 220/230V	60Hz 110V	50Hz 220/230V

Transmitter connection leads – Part numbers	
Mains lead - USA	17/PM1748 E14 – USA
Mains lead – UK	17/PM1748 E14 – UK
Mains lead – Europlug	17/PM1748 E14 – EURO
DC power lead (red/black)	17/PM1748 E10
Signal output lead (green/white)	17/PM1748 E11
PCM to PC Upload lead	17/CS Lead 76
PC Software	
PCM to PC Upload software discs	52/PM2093 PC

Pipeline Current Mapper User Guide

Section 14

Acknowledgements

The author thanks the following contributors:-

Gordon Parker, Radiodetection Canada, Applications Specialist.
Barney Walker, Radiodetection Bristol, Technical Support.

New information is always available from Radiodetection's website

<http://www.radiodetection.com>

Pipeline Current Mapper User Guide

Appendix 1

Interfacing the Trimble GPS Pathfinder Pro XR, Pro XRS, and Power systems with the PCM

Introduction

This bulletin outlines the configuration and operation of Trimble's GPS Pathfinder Pro XR, Pro XRS and Power systems with the PCM devices manufactured by Radiodetection Limited.

These notes apply particularly to the following product versions:

- TSC1 Asset Surveyor version 5.21
- Pathfinder Office version 2.80
- Radiodetection PCM receivers built after July 2001 using software version 5.03 or later.

Procedure Overview

There are four steps to obtain results with the PCM system and the Trimble TSC1 GPS datalogger.

1. Before taking measurements, create a suitable Data Dictionary on the PC.
2. Download this data dictionary to the TSC1.
3. Configure the TSC1 to interface to the PCM.
4. Take the measurements with the PCM while collecting GPS data with the GPS Pathfinder system.
5. Using Pathfinder Office software, export the results in csv ASCII format to the PC.
6. Import these results into MS Excel to prepare the graphs.

Creating a Data Dictionary on your PC

A Data Dictionary is a description of the data format you wish to collect in the field with Trimble's Asset Surveyor software. Once a Data Dictionary has been created on your PC, you must transfer the Data Dictionary to the TSC1 Datalogger prior to fieldwork.

Use the following procedure to create a suitable Data Dictionary on the PC:

- 1) Run the Pathfinder Office software, and select "Utilities/Data Directory Editor".
- 2) Select 'Points' and Name the file (File name)
- 3) Select 'New feature': Feature Name, "measuring points".
- 4) Click on 'Points' then click on 'OK'
- 5) Now touch key 'F7': "New Attributes". Choose 'Text'. Add Attribute name.
- 6) The comments field defaults to 30 characters, and it is possible to amend the default for up to 100 characters.
- 7) Click on 'close', 'save', and 'close'. Now the Data Dictionary is ready to upload to the TSC1 datalogger.

Transferring the configuration to the TSC1.

- 1) Connect the TSC1 and the PC using the Trimble serial cable.
- 2) Switch on the TSC1 (green button).
- 3) From the TSC1 Main Menu, select "File Manager".
- 4) In the "File Manager" menu, scroll down to 'File Transfer'; press Enter.
- 5) On the PC, run the Pathfinder Office software.
- 6) Select 'Utilities/Data Transfer'.
- 7) After successful connection has been established between the PC and the TSC1, you will see "ID sent" followed by "directory sent" on the TSC1 screen and the PC will display "Connected to GIS Datalogger".
- 8) Click on the 'Send' tab on the PC.
- 9) Select the "Add" option; Scroll down to 'Data Directory' and select the Data Dictionary you created in the previous step.
- 10) Press the 'Transfer all' button. After transferring the selected Data Dictionary to the TSC1, the PC will display the following message: "1 file successfully transferred".
- 11) Select 'Close' on the PC.

Pipeline Current Mapper User Guide

Appendix 1

Your Data Dictionary TSC1 has now been transferred to the TSC1.

Programming the TSC1

Do not connect the TSC1 to the GPS system until after configuration has been completed. This configuration process is necessary to set up the TSC1 to interface with the PCM. In the terminology of Trimble's Asset Surveyor software, the PCM is treated as an "external sensor". The configuration procedure is as follows:

- 1) Turn on the TSC1. The "Main Menu" will appear on the screen:

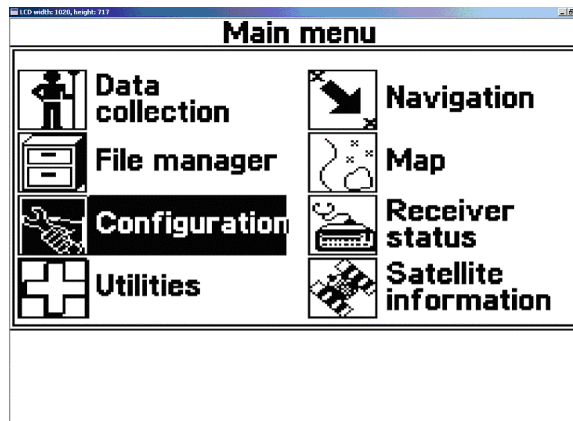

- 2) From the TSC1's "Main Menu", select "Configuration". The "Configuration" menu appears:

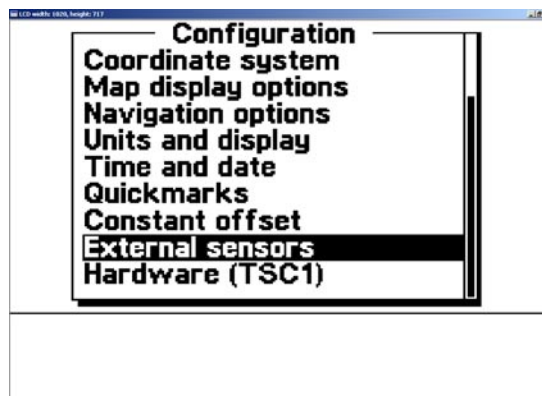

Pipeline Current Mapper User Guide

Appendix 1

- 3) Select 'External sensors' from the "Configuration" menu. The "Select sensor" menu appears:

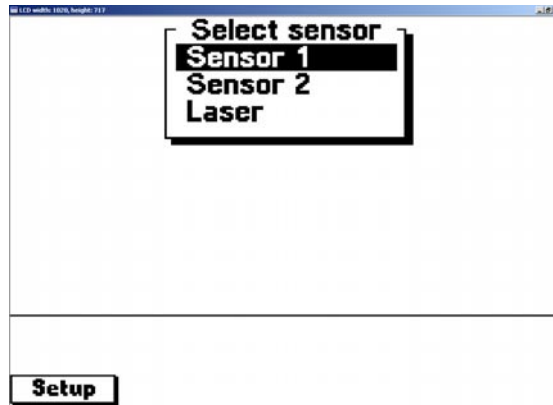

- 4) Press the F1 key ("Setup") to configure "Sensor 1". The configuration form appears. Change each of the lines as illustrated in the following two screens:

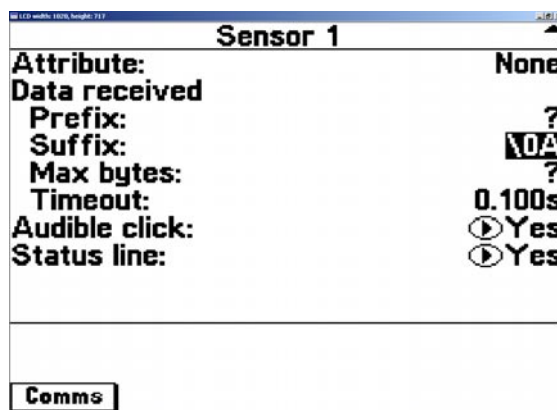
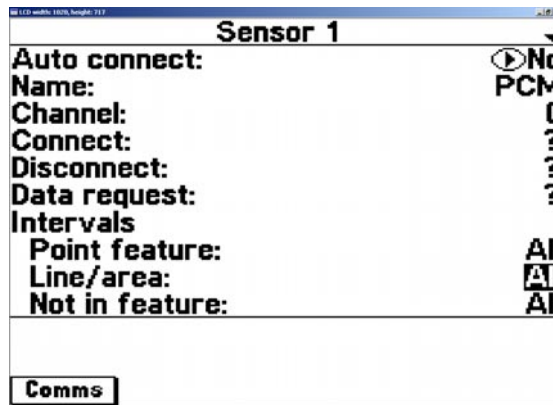

Pipeline Current Mapper User Guide

Appendix 1

- 5) The PCM sensor has now been configured, with the exception of its Serial RS232 communications parameters. To configure these parameters, press the F1 (Comms) key. The “Comms Setup” screen will appear. Enter the configuration exactly as it appears in the following illustration, with the exception that the designated Serial Port should be “Top”:

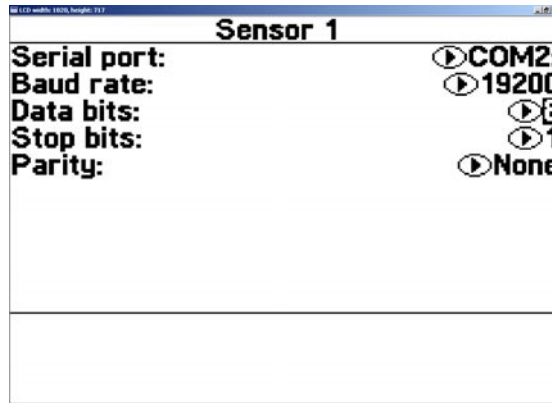

Note: If the “Comms” button is not available, it’s possible that another pre-configured sensor or laser already has the sensor port open. If this is the case, check the other sensor/laser options and make sure none are enabled (this is indicated by a tick next to the device).

- 6) Press ‘Enter’ to save the Comms parameters for Sensor 1. Press “Enter” again to save the configuration for the PCM sensor. The list of available sensors should now appear as illustrated in the following screen snap. Activate the PCM interface by selecting it from the menu (a tick will appear next to its name in the list):

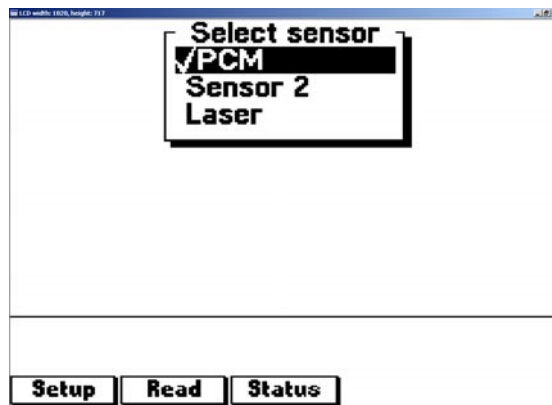

The TSC1 Asset Surveyor software is now configured for use with the PCM as an external sensor.

Taking measurements with the TSC1 and PCM

- 1) Connect the TSC1 to the GPS backpack by plugging the cable into the **Bottom** port of the TSC1.
- 2) Connect the PCM to the TSC1 by plugging the cable into the **Top** port of the TSC1 (and the port on the back of the PCM receiver).

Note: The cable that connects the PCM to the TSC1 is different from the standard 9 pin, pin to pin PCM Upload Cable. To change the PCM output baud rate to 19200, pin 4 should be removed on a standard 9 pin, pin to pin RS232 cable. Data transmission from the PCM will be in the format F04.

- 3) Switch on the PCM and the TSC1. Move to the first measuring point and locate and pinpoint the pipeline.

Pipeline Current Mapper User Guide

Appendix 1

- 4) On the TSC1 create a new data file. Select 'Measuring point'. Press 'Enter'. Then press 'F3'. This prepares the TSC1 to receive the datastream from the PCM as an "External sensor".
- 5) On the PCM, Press the PCM key to take the pipeline current measurement. Confirm the reading by pressing the PCM key a second time. This will save the PCM data in the PCM magnetometer foot, and at the same time transmit the data to the TSC1 datalogger.
- 6) The TSC1 will beep and the counter in the bottom right hand corner of the LCD screen will count while this happens. The TSC1 will beep a second time. Press 'F3' again. The data is now saved in the TSC1. Move to the next measuring point.
- 7) This routine of 'Enter', 'F3', PCM key, PCM key, 'F3' is repeated at every measurement point until the survey is completed.
- 8) The latest data stored can be viewed by pressing 'F3' Status and F3 Ext. Note that only the first part of the datastream is shown on the TSC1 LCD.

When you return to the office, you should download data from the TSC1 to Trimble's Pathfinder Office software using the normal data transfer procedure as documented in the Pathfinder Office on-line help and/or User Manual.

Exporting TSC1 data to Trimble's Pathfinder Office Software

1. In the Pathfinder Office software, select "Utilities/ Export". The "Export" Utility will appear:

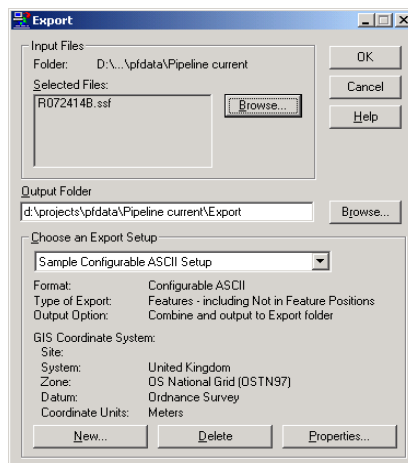

2. Click on the "Properties" button and choose the settings shown in each of the following windows.

First the **Data** Tab:

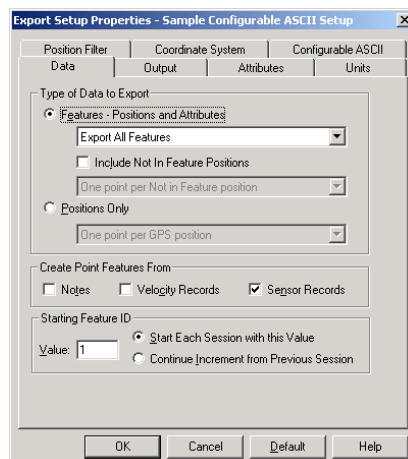

Pipeline Current Mapper User Guide

Appendix 1

3. Then the **Output** Tab:

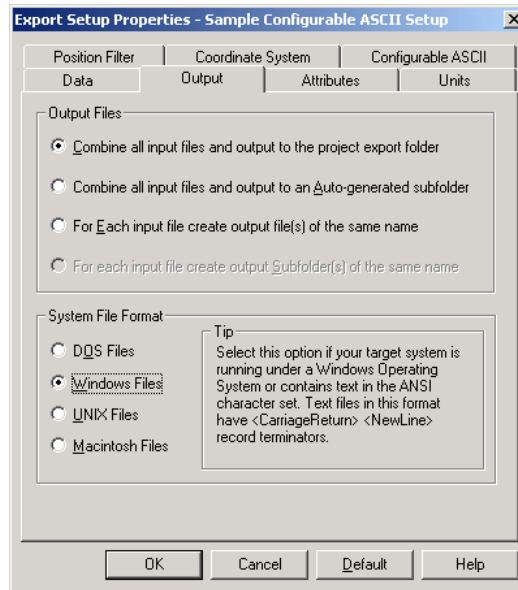

4. The **Attributes** tab:

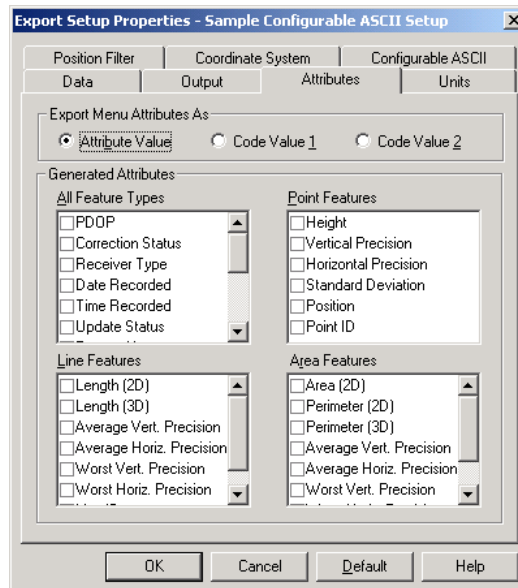

Note: No generated attributes should be ticked.

Pipeline Current Mapper User Guide

Appendix 1

5. The **Units** tab:

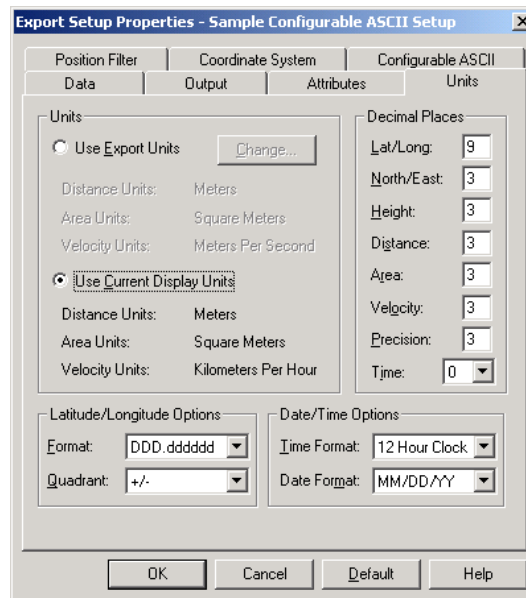

6. The **Position Filter** tab:

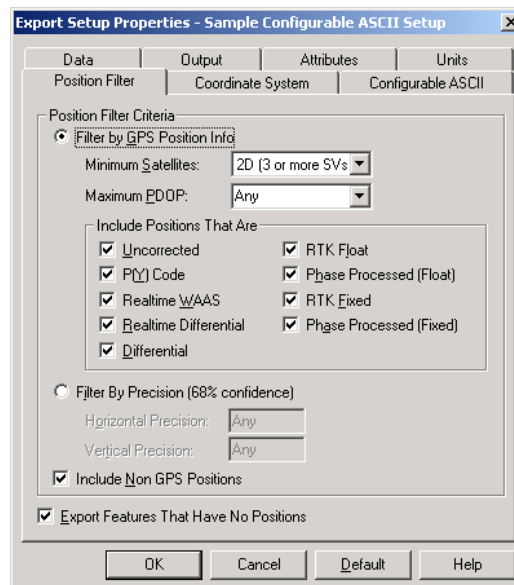

Pipeline Current Mapper User Guide

Appendix 1

7. The **Coordinate System** tab:

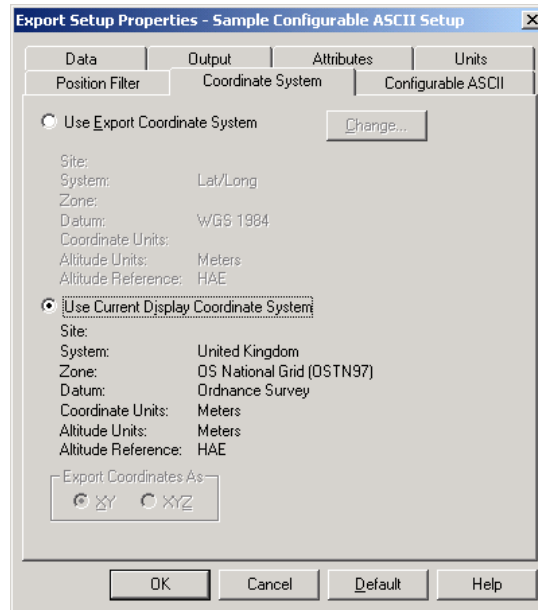

8. The **Configurable ASCII** tab:

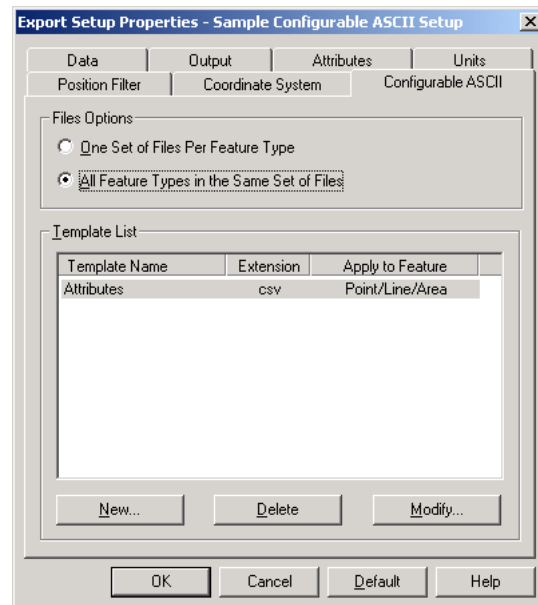

Pipeline Current Mapper User Guide

Appendix 1

9. You now need to create a “Template”. Carefully enter the template format illustrated in the next screen:

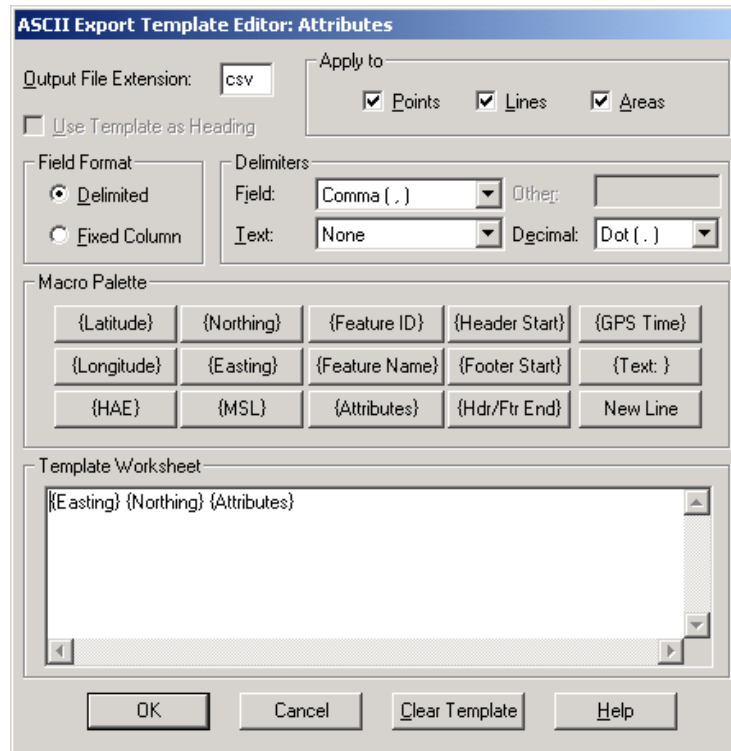

10. Save all these settings and the file will export as a list of coordinates with corresponding PCM measurements.

You will notice that you now have a list of all the readings with coordinates, followed by a list of all the coordinates again. These can easily be deleted.

Note: *If you do not need to reference the positions of the measuring points in real time you do not need to create them. When you send the data from the PCM foot, the Asset Surveyor software actually takes a position automatically when it receives each measurement. Then when you export data from the Pathfinder Office software you will have only the coordinates and the measurement data. (i.e. not a repeat of the coordinates afterwards). However in this case there would be no way to navigate back to points in the field unless you create one. The advantage with this though is that whenever you send data from the foot you will always get a position – even if you forget to go into a “measuring point “ feature. This results in always having data at the correct point.*

Importing Data into Excel

When you import data into Excel, you will have columns representing the North and East coordinates for each measurement, followed by all the Attributes (being the PCM datastream in F04 format).

Below these will be a second list of the same coordinates in real time. These can be deleted if not required for navigating back to the points in the field???

To Do:

1. **Snaps of initial DD creation?**
2. **Iron out the format issues**
3. **Illustrate the final data**
4. **Show how it's graphed in Excel.**

Pipeline Current Mapper User Guide

Appendix 1

Radiodetection Ltd
Western Drive
Bristol BS14 0AZ, UK
Tel: +44 (0) 117 976 7776
Fax: +44 (0) 117 976 7775
email:sales.uk@radiodetection.spx.com
<http://www.radiodetection.com>



Radiodetection

Riser Bond Dielectric Technologies
Bicotest Pearpoint Telespec

Radiodetection products are under continuous development and are subject to change without notice.

All rights reserved

90/UG14EN07